

Dell™ Dimension™ 2350 Series

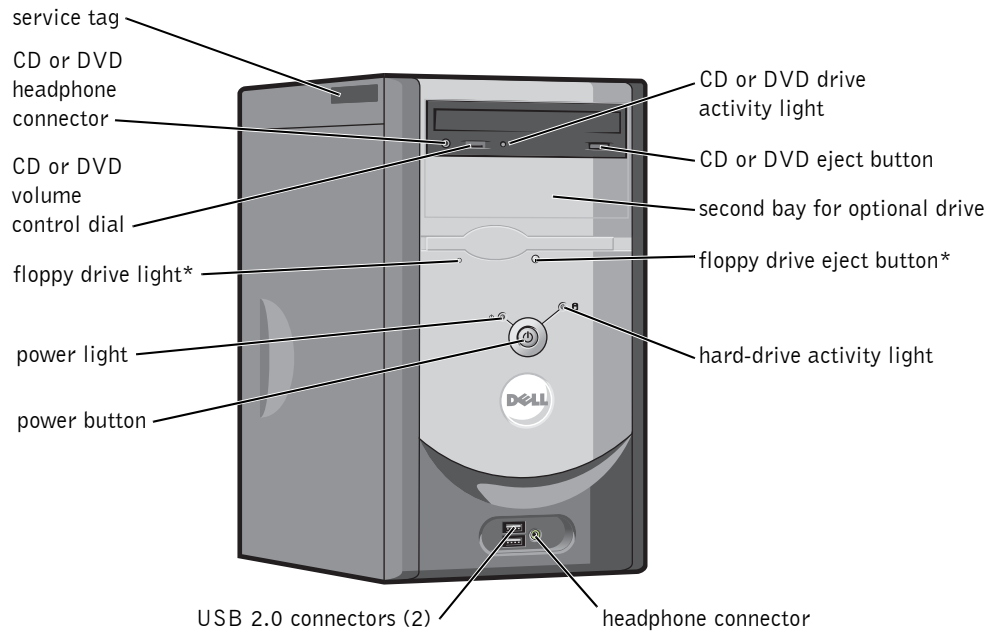

*On computers with an optional floppy drive.

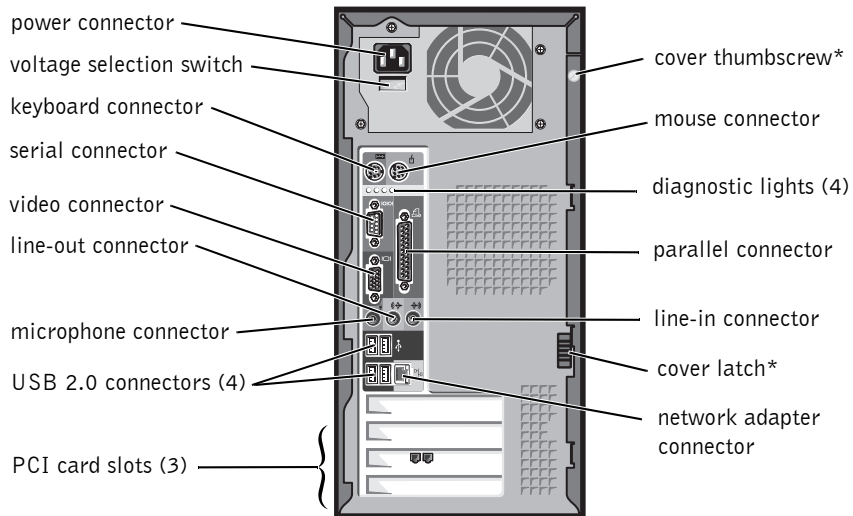

*Your computer may not have a cover thumbscrew or a cover latch.



Notes, Notices, and Cautions



NOTE: A NOTE indicates important information that helps you make better use of your computer.



NOTICE: A NOTICE indicates either potential damage to hardware or loss of data and tells you how to avoid the problem.



CAUTION: A CAUTION indicates a potential for property damage, personal injury, or death.

Abbreviations and Acronyms

For a complete list of abbreviations and acronyms, see the *Tell Me How* help file. To access the help file, see page 34.

If you purchased a Dell™ n Series computer, any references in this document to Microsoft® Windows® operating systems are not applicable.

Information in this document is subject to change without notice.

© 2003 Dell Computer Corporation. All rights reserved.

Reproduction in any manner whatsoever without the written permission of Dell Computer Corporation is strictly forbidden.

Trademarks used in this text: *Dell*, the *DELL* logo, *DellNet*, *Inspiron*, *Dell Precision*, *Dimension*, *OptiPlex*, and *Latitude* are trademarks of Dell Computer Corporation; *Intel*, *Celeron*, and *Pentium* are registered trademarks of Intel Corporation; *Microsoft* and *Windows* are registered trademarks of Microsoft Corporation.

Other trademarks and trade names may be used in this document to refer to either the entities claiming the marks and names or their products. Dell Computer Corporation disclaims any proprietary interest in trademarks and trade names other than its own.

March 2003 P/N K0511 Rev. A00

Contents

CAUTION: Safety Instructions	9
General	9
When Using Your Computer	11
When Working Inside Your Computer	12
Protecting Against Electrostatic Discharge	13
Ergonomic Computing Habits	13
Battery Disposal	14
Finding Information for Your Computer	15

1 Setting Up and Using Your Computer

Setting Up a Printer	20
Printer Cable	20
Connecting a Parallel Printer	20
Connecting a USB Printer	21
Transferring Information to a New Computer	22
Setting Up a Home and Office Network	23
Connecting to a Network Adapter	23
Network Setup Wizard	24
Connecting to the Internet	25
Setting Up Your Internet Connection	25

Copying CDs	26
Using Easy CD Creator Basic	27
Using Blank CD-R Discs or Blank CD-RW Discs	28
Helpful Tips	28
How to Copy a CD	29
Turning Off the Computer	30

2 Solving Problems

Finding Solutions	32
Finding Help Information	34
Battery Problems	34
Drive Problems	35
Floppy drive problems	35
CD drive problems	36
Problems writing to a CD-RW drive	36
DVD drive problems	37
Hard drive problems	37
E-Mail, Modem, and Internet Problems	37
Error Messages	39
General Problems	40
The computer stops responding	40
A program stops responding	40
A program crashes repeatedly	41
A program is designed for an earlier Windows operating system	41
A solid blue screen appears	41
Other software problems	41
Other technical problems	42
General hardware problems	42

Keyboard Problems	43
Mouse Problems	44
Network Problems	45
Power Problems	45
Printer Problems	46
Scanner Problems	47
Sound and Speaker Problems	48
No sound from speakers	48
No sound from headphones	49
Video and Monitor Problems	50
If the screen is blank	50
If the screen is difficult to read	51

3 Advanced Troubleshooting

Diagnostic Lights	54
Dell Diagnostics	56
When to Use the Dell Diagnostics	56
Starting the Dell Diagnostics	56
Drivers	59
What Is a Driver?	59
Identifying Drivers	59
Reinstalling Drivers	60
Using System Restore	61
Creating a Restore Point	61
Restoring the Computer to an Earlier Operating State	61
Undoing the Last System Restore	62
Resolving Software and Hardware Incompatibilities	63

Reinstalling Microsoft® Windows® XP	64
Before You Reinstall	64
Reinstalling Windows XP	64

4 Adding Parts

Front and Back View of the Computer	68
Front View	68
Back View	70
Removing the Computer Cover	71
Looking Inside Your Computer	73
System Board	74
Adding Cards	75
Adding a Second CD or DVD Drive	78
Adding Memory	83
Adding a Floppy Drive	85
Replacing the Computer Cover	90

5 Appendix

Specifications	92
Standard Settings	95
Viewing Settings	96
System Setup Program Screens	96
Clearing Forgotten Passwords	97
Replacing the Battery	98

Dell Technical Support Policy (U.S. Only)	99
Definition of "Dell-Installed" Software and Peripherals	100
Definition of "Third-Party" Software and Peripherals	100
Contacting Dell	100
Returning Items for Warranty Repair or Credit	118
Regulatory Notices	118
NOM Information (Mexico Only)	119
Limited Warranties and Return Policy	121
Limited Warranty for the U.S.	121
"Total Satisfaction" Return Policy (U.S. Only)	124
Limited Warranty Terms for Canada	125
"Total Satisfaction" Return Policy	128
Dell Software and Peripherals	129
One-Year End-User Manufacturer Guarantee (Latin America and the Caribbean Only)	130
Intel® Warranty Statement for Pentium® and Celeron® Processors Only (U.S. and Canada Only)	131
 Index	 133

CAUTION: Safety Instructions

Use the following safety guidelines to help ensure your own personal safety and to help protect your computer and working environment from potential damage.

General

- Do not attempt to service the computer yourself unless you are a trained service technician. Always follow installation instructions closely.
- To help prevent electric shock, plug the computer and device power cables into properly grounded electrical outlets. These cables are equipped with 3-prong plugs to help ensure proper grounding. Do not use adapter plugs or remove the grounding prong from a cable. If you must use an extension cable, use a 3-wire cable with properly grounded plugs.



- To help avoid the potential hazard of electric shock, do not use your computer during an electrical storm.
- To help avoid the potential hazard of electric shock, do not connect or disconnect any cables or perform maintenance or reconfiguration of this product during an electrical storm.
- If your computer includes a modem, the cable used with the modem should be manufactured with a minimum wire size of 26 American wire gauge (AWG) and an FCC-compliant RJ-11 modular plug.
- Before you clean your computer, disconnect the computer from the electrical outlet. Clean your computer with a soft cloth dampened with water. Do not use liquid or aerosol cleaners, which may contain flammable substances.
- To help avoid possible damage to the system board, wait 5 seconds after turning off the computer before disconnecting a device from the computer.

CAUTION: Safety Instructions (*continued*)

- To avoid shorting out your computer when disconnecting a network cable, first unplug the cable from the network adapter on the back of your computer, and then from the network jack. When reconnecting a network cable to your computer, first plug the cable into the network jack, and then into the network adapter.
- To help protect your computer from sudden, transient increases and decreases in electrical power, use a surge suppressor, line conditioner, or uninterruptible power supply (UPS).
- Be sure nothing rests on your computer's cables and that the cables are not located where they can be stepped on or tripped over.
- Do not push any objects into the openings of your computer. Doing so can cause fire or electric shock by shorting out interior components.
- Keep your computer away from radiators and heat sources. Also, do not block cooling vents. Avoid placing loose papers underneath your computer; do not place your computer in a closed-in wall unit or on a bed, sofa, or rug.

When Using Your Computer

As you use your computer, observe the following safe-handling guidelines.

⚠ CAUTION: Do not operate your computer with any cover(s) (including computer covers, bezels, filler brackets, front-panel inserts, and so on) removed.

- Your computer is equipped with one of the following:
 - A fixed-voltage power supply — Computers with a fixed-voltage power supply do not have a voltage selection switch on the back panel and operate at only one voltage (see the regulatory label on the outside of the computer for its operating voltage).
 - An auto-sensing voltage circuit — Computers with an auto-sensing voltage circuit do not have a voltage selection switch on the back panel and automatically detect the correct operating voltage.
 - A manual voltage selection switch — Computers with a voltage selection switch on the back panel must be manually set to operate at the correct operating voltage.



- ➡ NOTICE:** To help avoid damaging a computer with a manual voltage selection switch, set the switch for the voltage that most closely matches the AC power available in your location. For Japan, the voltage selection switch must be set to the 115-V position even though the AC power available in Japan is 100 V. Also, ensure that your monitor and attached devices are electrically rated to operate with the AC power available in your location.
- Before working inside the computer, unplug the computer to help prevent electric shock or system board damage. Certain system board components continue to receive power any time the computer is connected to AC power.

When Using Your Computer (*continued*)

When Working Inside Your Computer

Before you open the computer cover, perform the following steps in the sequence indicated.



CAUTION: Do not attempt to service the computer yourself, except as explained in your online Dell™ documentation or otherwise provided to you. Always follow installation and service instructions closely.



NOTICE: To help avoid possible damage to the system board, wait 5 seconds after turning off the computer before removing a component from the system board or disconnecting a device from the computer.

- 1 Perform an orderly computer shutdown using the operating system menu.
- 2 Turn off your computer and any devices connected to the computer.
- 3 Ground yourself by touching an unpainted metal surface on the chassis, such as the metal around the card-slot openings at the back of the computer, before touching anything inside your computer.

While you work, periodically touch an unpainted metal surface on the computer chassis to dissipate any static electricity that might harm internal components.

- 4 Disconnect your computer and devices, including the monitor, from their electrical outlets. Also, disconnect any telephone or telecommunication lines from the computer.

Doing so reduces the potential for personal injury or shock.

In addition, take note of these safety guidelines when appropriate:

- When you disconnect a cable, pull on its connector or on its strain-relief loop, not on the cable itself. Some cables have a connector with locking tabs; if you are disconnecting this type of cable, press in on the locking tabs before disconnecting the cable. As you pull connectors apart, keep them evenly aligned to avoid bending any connector pins. Also, before you connect a cable, ensure that both connectors are correctly oriented and aligned.

When Using Your Computer (*continued*)

- Handle components and cards with care. Do not touch the components or contacts on a card. Hold a card by its edges or by its metal mounting bracket. Hold a component such as a microprocessor chip by its edges, not by its pins.

 **CAUTION: There is a danger of a new battery exploding if it is incorrectly installed. Replace the battery only with the same or equivalent type recommended by the manufacturer. Do not dispose of the battery along with household waste. Contact your local waste disposal agency for the address of the nearest battery deposit site.**

Protecting Against Electrostatic Discharge

Static electricity can harm delicate components inside your computer. To prevent static damage, discharge static electricity from your body before you touch any of your computer's electronic components, such as the microprocessor. You can do so by touching an unpainted metal surface on the computer chassis.

As you continue to work inside the computer, periodically touch an unpainted metal surface to remove any static charge your body may have accumulated.

You can also take the following steps to prevent damage from electrostatic discharge (ESD):

- Do not remove components from their antistatic packing material until you are ready to install the component in your computer. Just before unwrapping the antistatic packaging, discharge static electricity from your body.
- When transporting an electrostatic sensitive component, first place it in an antistatic container or packaging.
- Handle all electrostatic sensitive components in a static-safe area. If possible, use antistatic floor pads and workbench pads.

Ergonomic Computing Habits

 **CAUTION: Improper or prolonged keyboard use may result in injury.**

 **CAUTION: Viewing the monitor screen for extended periods of time may result in eye strain.**

For comfort and efficiency, observe the ergonomic guidelines in the *Tell Me How* help file when setting up and using your computer. To access the *Tell Me How* help file, see "Finding Help Information" on page 34.

When Using Your Computer (*continued*)



Battery Disposal

Your computer uses a lithium coin-cell battery. The lithium coin-cell battery is a long-life battery, and it is very possible that you will never need to replace it. However, should you need to replace it, see "Replacing the Battery" on page 98.

Do not dispose of the battery along with household waste. Contact your local waste disposal agency for the address of the nearest battery deposit site.

Finding Information for Your Computer

What Are You Looking For?

Find it Here

- A diagnostic program for my computer
- Drivers for my computer
- My computer documentation
- My device documentation

Resource CD



You can use this CD to access documentation and reinstall drivers (see page 60).

-
- How to set up a printer
 - How to troubleshoot and solve problems
 - How to add parts
 - How to contact Dell
 - Warranty information

Owner's Manual

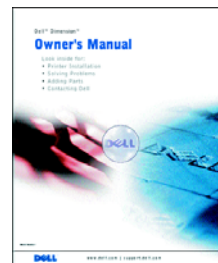

-
- Express Service Code and Service Tag Number
 - Microsoft® Windows® License Label

Express Service Code and Windows License Label



Located on your computer (see page 68).

What Are You Looking For?

- How to reinstall my operating system

Find it Here

Operating System CD



If you reinstall your operating system, use the ResourceCD to reinstall drivers for the devices that came with your computer (see page 60).

- Latest drivers for my computer
- Answers to technical service and support questions
- Online discussions with other users and technical support
- Documentation for my computer

Dell Support website

The Dell Support website provides several online tools, including:

- Knowledge Base — hints, tips, and online courses
- Customer Forum — online discussion with other Dell customers
- Upgrades — upgrade information for components, such as memory, the hard drive, and the operating system
- Customer Care — contact information, order status, warranty, and repair information
- Downloads — drivers, patches, and software updates
- Reference — computer documentation, product specifications, and white papers

- How to set up my computer

Setup diagram



What Are You Looking For?	Find it Here
<ul style="list-style-type: none"> • Tips on using Windows • How to clean my computer • How to use my mouse and keyboard 	<p>Tell Me How help file</p> <ol style="list-style-type: none"> 1 Click the Start button, and then click Help and Support. 2 Click User and system guides, and then click User's guides. 3 Click Tell Me How.
<ul style="list-style-type: none"> • How to use Windows XP • Documentation for my computer and devices 	<p>Windows XP Help and Support Center</p> <ol style="list-style-type: none"> 1 Click the Start button, and then click Help and Support. 2 Type a word or phrase that describes your problem, and then click the arrow icon. 3 Click the topic that describes your problem. 4 Follow the instructions shown on the screen.

SECTION 1

Setting Up and Using Your Computer

Setting Up a Printer

Transferring Information to a New Computer

Setting Up a Home and Office Network

Connecting to the Internet

Copying CDs

Turning Off the Computer

Setting Up a Printer

➡ NOTICE: Complete the operating system setup before you connect a printer to the computer.

See the documentation that came with the printer for setup information, including how to:

- Obtain and install updated drivers
- Connect the printer to the computer
- Load paper and install the toner or ink cartridge
- Contact the printer manufacturer for technical assistance

Printer Cable

Your printer connects to your computer with either a USB cable or a parallel cable. Your printer may not come with a printer cable, so if you purchase a cable separately, ensure that it is compatible with your printer. If you purchased a printer cable at the same time you purchased your computer, the cable may arrive in the computer box.

Connecting a Parallel Printer

- 1 Complete the operating system setup, if you have not already done so.
- 2 Turn off the computer (see page 30).

➡ NOTICE: For best results, use a 3 m (10 ft) or shorter parallel cable.

- 3 Attach the parallel printer cable to the parallel connector on the computer and tighten the two screws. Attach the cable to the connector on the printer and snap the two clips into the two notches.

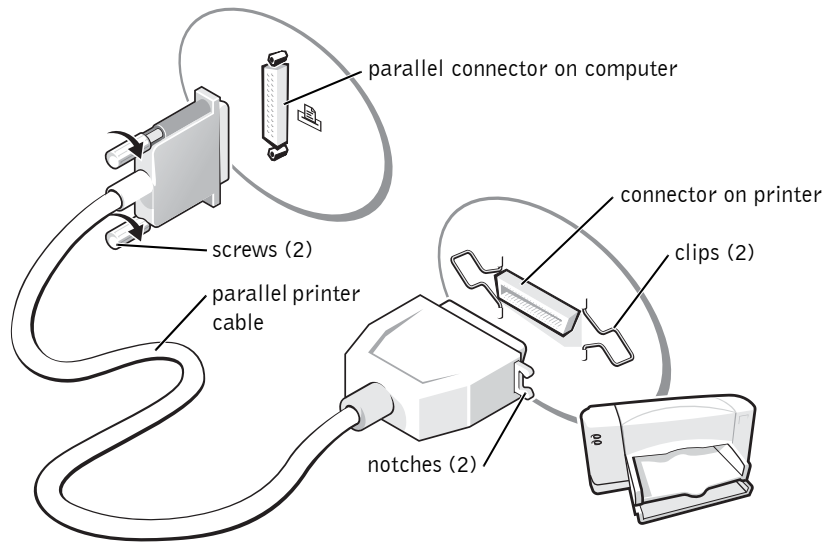

- 4 Turn on the printer and then turn on the computer. If the **Add New Hardware Wizard** window appears, click **Cancel**.
- 5 Install the printer driver if necessary. See the documentation that came with your printer.

Connecting a USB Printer

 **NOTE:** You can connect USB devices while the computer is turned on.

- 1 Complete the operating system setup, if you have not already done so.
- 2 Install the printer driver if necessary. See the documentation that came with your printer.
- 3 Attach the USB printer cable to the USB connector on the computer and the printer. The USB connectors fit only one way.

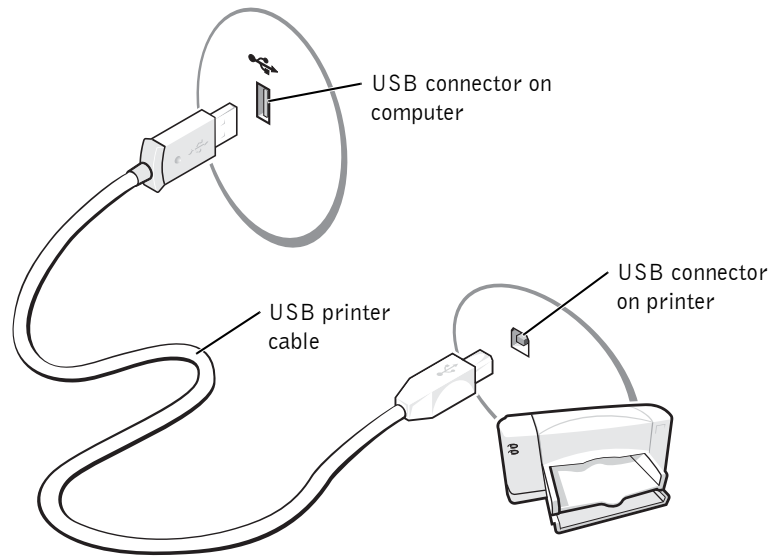

Transferring Information to a New Computer

Windows XP provides a Files and Settings Transfer Wizard to move data, such as e-mails, window sizes, toolbar settings, and Internet bookmarks from one computer to another. First you collect the data from the source computer, and then you import the data to the new computer.

If the source computer uses another Windows operating system, the wizard can be launched from the Windows XP operating system CD or from a floppy disk created on the Windows XP computer. You can transfer the data to the new computer over a network or serial connection, or you can store it on a removable medium, such as a floppy disk, a Zip disk, or a writable CD.

To transfer information to a new computer:

 **NOTE:** The CD that you need to place in your CD or DVD drive is titled *Operating System*.

- 1 Click the **Start** button, point to **All Programs**→**Accessories**→**System Tools**, and then click **Files and Settings Transfer Wizard**.
- 2 On the welcome screen, click **Next**.
- 3 On the **Which computer is this?** screen, select **New Computer**, and then click **Next**.
- 4 Follow the instructions on the screen.

Setting Up a Home and Office Network

Connecting to a Network Adapter

Before you connect your computer to a network, it must have a network adapter installed and a network cable connected to it.

To connect a network cable:

- 1 Connect the network cable to the network adapter connector on the back of your computer.

 **NOTE:** Insert the cable until it clicks into place, and then gently pull it to ensure that it is secure.

- 2 Connect the other end of the network cable to a network connection device.

 **NOTE:** Do not use a network cable with a telephone wall jack.

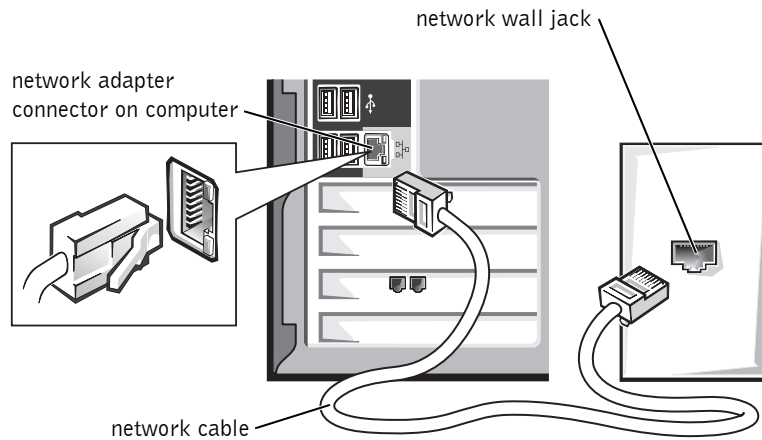

Network Setup Wizard

Windows XP provides a Network Setup Wizard to guide you through the process of sharing files, printers, or an Internet connection between computers in a home or small office.

- 1 Click the **Start** button, point to **All Programs**→**Accessories**→**Communications**, and then click **Network Setup Wizard**.
- 2 On the welcome screen, click **Next**.
- 3 Click **checklist for creating a network**.

 **NOTE:** Selecting the connection method **This computer connects directly to the Internet** enables the integrated firewall provided with Windows XP.

- 4 Complete the checklist and required preparations, and then return to the Network Setup Wizard.
- 5 Follow the instructions on the screen.

Connecting to the Internet

 **NOTE:** Internet service providers vary by country.

To connect to the Internet, you need a modem or network connection and an Internet service provider (ISP), such as America Online or DellNet™ by MSN. Your ISP will offer one or more of the following Internet connection options:

- Dial-up connections that provide Internet access through a phone line. Dial-up connections are considerably slower than DSL and cable modem connections.
- DSL connections that provide high-speed Internet access through your existing phone line. With a DSL connection, you can access the Internet and use your phone on the same line simultaneously.
- Cable modem connections that provide high-speed Internet access through your local cable TV line.

If you are using a dial-up connection, connect a telephone cable to the modem connector on your computer and to the telephone wall jack before you set up your Internet connection. If you are using a DSL or cable modem connection, contact your ISP for setup instructions.

Setting Up Your Internet Connection

To set up an America Online or DellNet by MSN connection:

- 1 Save any work in progress and close all open programs.
- 2 Double-click the **MSN Explorer** or **AOL** icon on the Windows® desktop.
- 3 Follow the instructions on the screen to complete the setup.

If you do not have an **MSN Explorer** or **AOL** icon on your desktop or if you want to set up an Internet connection with a different ISP:

- 1 Save any work in progress and close all open programs.
- 2 Click the **Start** button and click **Control Panel**.
- 3 Click **Network and Internet Connections**.
- 4 Click **Set up or change your Internet connection**.
- 5 In the **Internet Properties** window, click **Setup** and then click **Next**.
The **New Connection Wizard** appears.
- 6 Click **Connect to the Internet**.

- 7 In the next window, click the appropriate option:
 - If you do not have an ISP and want to select one, click **Choose from a list of Internet service providers (ISPs)**.
 - If you have already obtained setup information from your ISP but you did not receive a setup CD, click **Set up my connection manually**.
 - If you have a CD, click **Use the CD I got from an ISP**.

- 8 Click **Next**.

If you selected **Set up my connection manually**, continue to step 9. Otherwise, follow the instructions on the screen to complete the setup.

 **NOTE:** If you do not know which type of connection to select, contact your ISP.

- 9 Click the appropriate option under **How do you want to connect to the Internet?**, and then click **Next**.

- 10 Use the setup information provided by your ISP to complete the setup.

If you are having problems connecting to the Internet, see "Internet, Modem, and E-Mail Problems" on page 37. If you cannot connect to the Internet but have successfully connected in the past, the ISP might have a service outage. Contact your ISP to check the service status, or try connecting again later.

Copying CDs

 **NOTE:** Ensure that you follow all copyright laws when you create CDs.

This section applies only to computers that have a CD- or DVD-recording device.

The information in this section is based on the Roxio Easy CD Creator Basic documentation that came with your computer. See the following section, "Using Easy CD Creator Basic," for instructions on how to locate that documentation.

 **NOTE:** The information in this section also applies to using Easy CD Creator Basic with a DVD+RW or a DVD+R drive.

To burn CDs, you need to use CD-burner software. Roxio Easy CD Creator Basic is your computer's CD-burner software. The software includes these project programs that enable you to record specialty CDs for different types of uses:

- DirectCD allows you to format a blank CD-R or CD-RW disc so that you can use Microsoft® Windows® Explorer to drag and drop data files to the CD-RW drive. You can use a DirectCD-formatted CD-RW disc like another hard drive on your computer because CD-RW discs are fully rewritable (CD-R discs can be used with DirectCD, but that media type has overwriting limitations—see "Using Blank CD-R Discs or Blank CD-RW Discs" for recording media differences).
- MusicCD allows you to burn custom music CDs.
- DataCD allows you to copy a variety of your documents, such as spreadsheet or accounting files, to a CD for permanent storage.



NOTE: Some music and game CDs are copy-protected. If you have a CD that cannot be copied, you must use the original CD for everyday use.

- Disc Copier allows you to make a backup copy of almost any type of CD. This program allows you to make a copy of a CD for everyday use so that you can archive and save the original copy. (Disc Copier is titled "CD Copier" in some versions of Roxio CD Creator Basic.)

All four project programs are available on the Easy CD Creator Basic **Select a Project** menu screen. To view the **Select a Project** menu screen, click the **Start** button, point to **All Programs**→ **Roxio Easy CD Creator**, and then click **Project Selector**.

Using Easy CD Creator Basic

See the Easy CD Creator Basic documentation for instructions on how to use the program, information about different recording techniques, and CD media limitations. The Easy CD Creator Basic documentation is located in the Microsoft® Windows® XP Help and Support Center (see "Finding Help Information" on page 34). The documentation is also provided on the *Dell Dimension ResourceCD*, which is included with your computer. Each Easy CD Creator Basic project program also has thorough online help files.

Using Blank CD-R Discs or Blank CD-RW Discs

Your CD-RW drive writes to two different types of recording media—CD-R and CD-RW discs. Use blank CD-R (CD-Recordable) disks to record music or permanently store data files. After creating a CD-R disc, you cannot write to that disc again without changing your method of recording (see the Roxio documentation for more information). Use blank CD-RW (CD-ReWritable) discs when you want to write, erase, rewrite, and update your files onto CDs.

Helpful Tips

- You must use the Easy CD Creator Basic project programs to copy and record all music and data CDs. You can use Windows Explorer to drag and drop files to a CD-R or CD-RW disc only after you first use DirectCD to format the disc.
- You must use CD-R discs to burn music CDs that you want to play in regular stereos. CD-RW discs do not play in most home or car stereos.
- If you want to copy files from the Internet or files from a floppy or Zip drive, copy those files to your hard drive first, and then burn your CD. Your CD-RW drive requires a steady stream of data to properly record. Direct Internet downloads, floppy drives, and Zip drives may not be able to provide a steady data stream to your CD-RW drive.
- Music MP3 files can be played only on MP3 players or on computers that have MP3 software installed.
- Ensure that you set the sampling rate to at least 128 Kbps when you burn MP3 files to a CD. Otherwise, recording errors may occur.
- Do not burn a blank CD-R or CD-RW disc to its maximum capacity; for example, do not copy a 650-MB file to a 650-MB blank CD. The CD-RW drive needs 1 or 2 MB of the blank CD to finalize the recording.
- Use a blank CD-RW disc to practice CD recording until you are familiar with CD recording techniques. If you make a mistake, you can erase the CD-RW disc and try again. You can also use blank CD-RW discs to test music file projects before you record the project permanently to a blank CD-R disc.
- See the Roxio support website at support.roxio.com for additional helpful tips.

How to Copy a CD

 **NOTE:** If you have a DVD/CD-RW combo drive and you experience recording problems, first check for available software patches at the Dell Support website at support.dell.com and if necessary, the Roxio support website at support.roxio.com.

The procedure assumes that your computer is equipped with a single CD-RW drive (without an additional CD drive). If your computer is equipped with both types of drives, see the Roxio documentation for instructions on how to copy CDs from a CD drive to a CD-RW drive.

- 1 Click the **Start** button, point to **All Programs**→ **Roxio Easy CD Creator**, and then click **Project Selector**.

The **Select a Project** window appears.

- 2 Click **Disc Copier**. (Disc Copier is titled "CD Copier" in some versions of Easy CD Creator Basic.)

The **Disc Copier** window appears and displays your CD-RW drive in the **Copy from** and the **Record to** lists.

- 3 Insert the source CD that you want to copy into the CD-RW drive.

The Disc Copier project program briefly checks the source CD in the CD-RW drive to ensure that it is a readable CD.

- 4 Click **Copy**.

Depending on the size of the files that are being copied, the copy process may take a few minutes.

- 5 After the source CD is copied, remove the source CD from the CD-RW drive tray.

The CD-RW drive tray opens automatically after the source CD is copied.

 **NOTE:** You must use CD-R discs to burn music CDs that you want to play in regular stereos. CD-RW discs do not play in most home or car stereos.

- 6 Insert a blank CD into the CD-RW drive and close the tray.

The recording starts automatically.

- 7 After the recording completes, click **OK**.

Turning Off the Computer

 **NOTICE:** To prevent data loss, you must turn off your computer through the **Start** menu rather than by pressing the power button.

 **NOTE:** If you are having difficulty turning off your computer, see "General Problems" on page 40.

- 1 Save and close any open files and exit any open programs.
- 2 Click the **Start** button and then click **Turn off Computer**.
- 3 Click **Turn off**.

The computer automatically turns off after the shutdown process finishes.

- 4 Turn off your monitor and any other devices connected to power.

SECTION 2

Solving Problems

- Finding Solutions
- Finding Help Information
- Battery Problems
- Drive Problems
- E-Mail, Modem, and Internet Problems
- Error Messages
- General Problems
- Keyboard Problems
- Mouse Problems
- Network Problems
- Power Problems
- Printer Problems
- Scanner Problems
- Sound and Speaker Problems
- Video and Monitor Problems

Finding Solutions

Sometimes it's difficult to figure out where to go for answers. Use this chart to help you quickly find the answers to your questions.

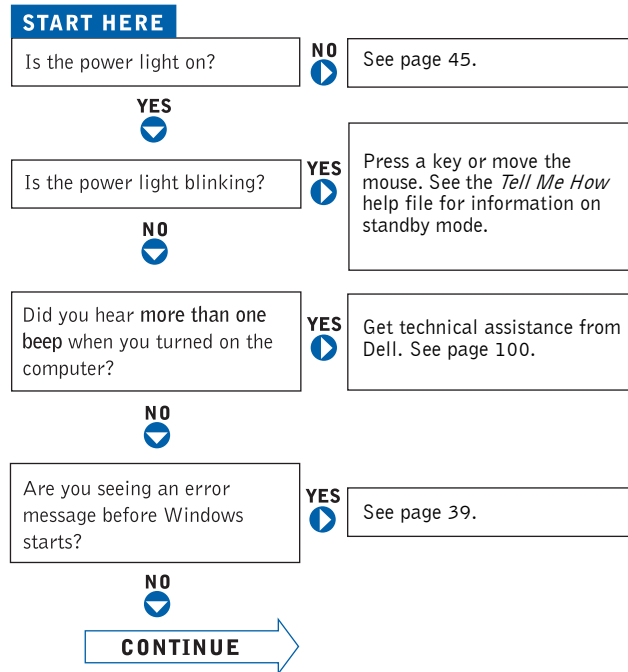

Are you having a problem with... NO	▶	video or the monitor?	YES ▶	See page 50.
		sound or the speakers?	YES ▶	See page 48.
		the printer?	YES ▶	See page 46.
		the modem?	YES ▶	See page 37.
		the mouse?	YES ▶	See page 44.
		the keyboard?	YES ▶	See page 43.
		the hard drive or a disk drive?	YES ▶	See page 35.
		the network adapter?	YES ▶	See page 45.
		the scanner?	YES ▶	See page 47.
		Windows error messages?	YES ▶	See page 39.
		a program?	YES ▶	See page 40.
		the Internet?	YES ▶	See page 37.
		your e-mail?	YES ▶	See page 37.
	Are you having some other type of problem?	YES ▶	See page 40.	

Finding Help Information

TO ACCESS THE *Tell Me How* HELP FILE —



- 1 Click the Start button, and then click **Help and Support**.
- 2 Click **User and system guides**, and then click **User's guides**.
- 3 Click **Tell Me How**.

TO ACCESS WINDOWS HELP —

- 1 Click the Start button, and then click **Help and Support**.
- 2 Type a word or phrase that describes your problem, and then click the arrow icon.
- 3 Click the topic that describes your problem.
- 4 Follow the instructions shown on the screen.

TO LOCATE ADDITIONAL INFORMATION FOR YOUR COMPUTER — See page 15.

Battery Problems

-  **CAUTION:** There is a danger of a new battery exploding if it is incorrectly installed. Replace the battery only with the same or equivalent type recommended by the manufacturer. Discard used batteries according to the manufacturer's instructions.
-  **CAUTION:** Before you begin any of the procedures in this section, follow the safety instructions on page 9.

REPLACE THE BATTERY — If you have to repeatedly reset time and date information after turning on the computer, or if an incorrect time or date displays during start-up, replace the battery (see page 98). If the battery still does not work properly, contact Dell (see page 100).

Drive Problems

Floppy drive problems

ENSURE THAT WINDOWS® RECOGNIZES THE DRIVE — Click the **Start** button and click **My Computer**. If the floppy drive is not listed, perform a full scan with your antivirus software to check for and remove viruses. Viruses can sometimes prevent Windows from recognizing the drive.

TEST THE DRIVE —

- Insert another disk to eliminate the possibility that the original floppy disk is defective.
- Insert a bootable floppy disk and reboot the computer.

ENSURE THAT THE DISK IS NOT FULL OR WRITE-PROTECTED — Ensure that the disk has available space and that it is not write-protected (locked). See the following illustration.

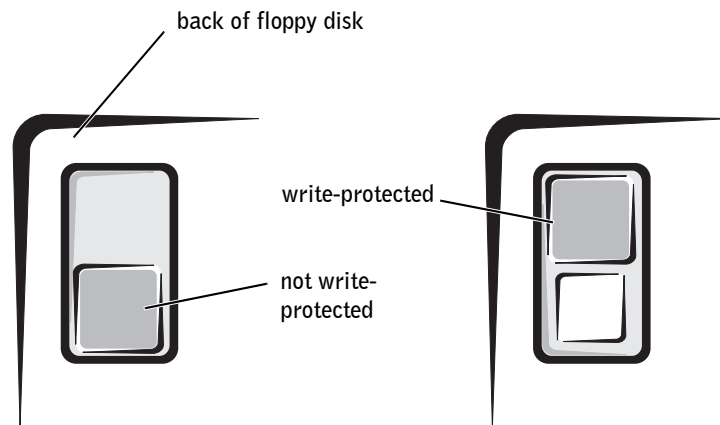

NOTICE: Do not attempt to clean drive heads with a swab. You may accidentally misalign the heads, which can render the drive inoperable.

CLEAN THE DRIVE — Use a commercially available cleaning kit.

CD drive problems

 **NOTE:** High-speed CD drive vibration is normal and may cause noise. This does not indicate a defect in the drive or the CD.

ADJUST THE WINDOWS VOLUME CONTROL — Click the speaker icon in the lower-right corner of your screen.

- Ensure that the volume is turned up by clicking the slider and dragging it up.
- Ensure that the sound is not muted by clicking any boxes that are checked.

TEST THE DRIVE WITH ANOTHER CD — Insert another CD to eliminate the possibility that the original CD is defective.

CHECK THE SPEAKERS AND SUBWOOFER — See "Sound and Speaker Problems" on page 48.

ENSURE THAT WINDOWS RECOGNIZES THE DRIVE — Click the Start button and click My Computer. If the CD drive is not listed, perform a full scan with your antivirus software to check for and remove viruses. Viruses can sometimes prevent Windows from recognizing the drive.

CLEAN THE DISC — See the *Tell Me How* help file for instructions on cleaning your CDs. To access help files, see page 34.

Problems writing to a CD-RW drive

CLOSE OTHER PROGRAMS — The CD-RW drive must receive a steady stream of data when writing. If the stream is interrupted, an error occurs. Try closing all programs before writing to the CD-RW.

TURN OFF STANDBY MODE IN WINDOWS BEFORE WRITING TO A CD-RW DISC — For information on power conservation modes, see the *Tell Me How* help file or search for the keyword *standby* in Windows Help. To access help files, see page 34.

DVD drive problems

 **NOTE:** Because of different regions worldwide and different disc formats, not all DVD titles work in all DVD drives.

TEST THE DRIVE WITH ANOTHER DVD — Insert another DVD to eliminate the possibility that the original DVD is defective.

ENSURE THAT WINDOWS RECOGNIZES THE DRIVE — Click the **Start** button and click **My Computer**. If the DVD drive is not listed, perform a full scan with your antivirus software to check for and remove viruses. Viruses can sometimes prevent Windows from recognizing the drive.

CLEAN THE DISC — See the *Tell Me How* help file for instructions on cleaning your DVDs. To access help files, see page 34.

CHECK FOR INTERRUPT REQUEST CONFLICTS — See page 63.

Hard drive problems

RUN CHECK DISK —

- 1 Click the **Start** button and click **My Computer**.
- 2 Right-click the drive letter (local disk) that you want to scan for errors, and then click **Properties**.
- 3 Click the **Tools** tab.
- 4 Under **Error-checking**, click **Check Now**.
- 5 Click **Start**.

E-Mail, Modem, and Internet Problems

 **NOTE:** Connect the modem to an analog telephone jack only. The modem does not operate while it is connected to a digital telephone network.

CHECK THE TELEPHONE LINE CONNECTION — Verify that the telephone line is connected to the jack on the modem. (The jack has either a green label or a connector-shaped icon next to it.) Ensure that you hear a click when you insert the telephone line connector into the modem.

CHECK THE TELEPHONE JACK — Disconnect the telephone line from the modem and connect it to a telephone. Listen for a dial tone.

CONNECT THE MODEM DIRECTLY TO THE TELEPHONE WALL JACK — If you have other telephone devices sharing the line, such as an answering machine, fax machine, surge protector, or line splitter, then bypass them and use the telephone to connect the modem directly to the telephone wall jack.

USE A DIFFERENT TELEPHONE LINE — If you are using a line that is 3 m (10 ft) or more in length, try a shorter one.

RUN THE MODEM HELPER DIAGNOSTICS — Click the **Start** button, point to **All Programs**, and then click **Modem Helper**. Follow the instructions on the screen to identify and resolve modem problems. (Modem Helper is not available on all computers.)

VERIFY THAT THE MODEM IS COMMUNICATING WITH WINDOWS® — **1** Click the **Start** button, and then click **Control Panel**.

2 Click **Printers and Other Hardware**.

3 Click **Phone and Modem Options**.

4 Click the **Modems** tab.

5 Click the COM port for your modem.

6 Click **Properties**, click the **Diagnostics** tab, and then click **Query Modem** to verify that the modem is communicating with Windows.

If all commands receive responses, the modem is operating properly.

TURN OFF CALL WAITING (CATCH-PHONE) — See your telephone directory for instructions on deactivating this feature. Then adjust the dial-up networking connection properties.

1 Click the **Start** button, and then click **Control Panel**.

2 Click **Printers and Other Hardware**, and then click **Phone and Modem Options**.

3 Click your connection type to highlight it.

4 Click the **Dialing Rules** tab, and then click **Edit**.

5 Click the **To Disable Call Waiting** box to place a checkmark in it.

6 Select the disable code from the drop-down menu (for example, *70).

7 Click **Apply**, and then click **OK**.

ENSURE THAT YOU ARE CONNECTED TO THE INTERNET — With the Outlook Express e-mail program open, click **File**. If **Work Offline** has a checkmark next to it, click the checkmark to remove it and connect to the Internet.

ENSURE THAT YOU HAVE SUBSCRIBED TO AN INTERNET SERVICE PROVIDER — Contact an Internet service provider to subscribe.

CONTACT YOUR INTERNET SERVICE PROVIDER — Contact your Internet service provider for assistance.

Error Messages

If the message is not listed, see the documentation for the operating system or the program that was running when the message appeared.

A FILENAME CANNOT CONTAIN ANY OF THE FOLLOWING CHARACTERS: \ / : * ? " < > | — Do not use these characters in filenames.

A REQUIRED .DLL FILE WAS NOT FOUND — The program that you are trying to open is missing an essential file. To remove and then reinstall the program:

- 1 Click the **Start** button.
- 2 Click **Control Panel**.
- 3 Click **Add or Remove Programs**.
- 4 Select the program you want to remove.
- 5 Click the **Change or Remove Program** icon.
- 6 See the program documentation for installation instructions.

INSERT BOOTABLE MEDIA — The operating system is trying to boot to a nonbootable floppy disk or CD. Insert a bootable floppy disk or CD.

NON-SYSTEM DISK ERROR — A floppy disk is in the floppy drive. Remove the floppy disk and restart the computer.

NOT ENOUGH MEMORY OR RESOURCES. CLOSE SOME PROGRAMS AND TRY AGAIN —

You have too many programs open. Close all windows and open the program that you want to use. In some cases, you might have to restart your computer to restore computer resources. If so, try running the program that you want to use first.

OPERATING SYSTEM NOT FOUND — Contact Dell (see page 100).

THE FILE BEING COPIED IS TOO LARGE FOR THE DESTINATION DRIVE — The file that you are trying to copy is too large to fit on the disk. Try copying the file to a blank disk or using a larger-capacity disk.

A:\ IS NOT ACCESSIBLE. THE DEVICE IS NOT READY — The floppy drive cannot read the disk. Insert a floppy disk into the drive and try again.

General Problems

The computer stops responding

TURN THE COMPUTER OFF — If your computer locks up and you are unable to get a response by pressing a key on your keyboard or moving your mouse, press and hold the power button for at least 8 to 10 seconds until the computer turns off. Then press the power button again to turn on the computer. You might lose data if you are unable to perform an operating system shutdown.

A program stops responding

END THE PROGRAM —

- 1 Press <Ctrl><Shift><Esc> simultaneously.
- 2 Click **Applications**.
- 3 Click the program that is no longer responding.
- 4 Click **End Task**.

A program crashes repeatedly

 **NOTE:** Software usually includes installation instructions in its documentation or on a floppy disk or CD.

CHECK THE SOFTWARE DOCUMENTATION — Many software manufacturers maintain websites with information that may help you solve the problem. Ensure that you properly installed and configured the program. If necessary, uninstall and then reinstall the program.

A program is designed for an earlier Windows operating system

RUN THE PROGRAM COMPATIBILITY WIZARD —

Windows XP provides a Program Compatibility Wizard that configures a program so it runs in an environment similar to non-Windows XP operating system environments.

- 1 Click the **Start** button, point to **All Programs**→**Accessories**, and then click **Program Compatibility Wizard**.
- 2 In the welcome screen, click **Next**.
- 3 Follow the instructions on the screen.

A solid blue screen appears

TURN THE COMPUTER OFF — If the computer does not respond to a keystroke or a proper shutdown, press the power button for at least 8 to 10 seconds until the computer turns off. Press the power button again to restart the computer. The chkdsk program automatically runs during the start-up process. Follow the instructions on the screen.

Other software problems

CHECK THE SOFTWARE DOCUMENTATION OR CONTACT THE SOFTWARE MANUFACTURER FOR TROUBLESHOOTING INFORMATION

BACK UP YOUR FILES IMMEDIATELY — If your computer has a CD-RW drive or a zip drive installed, see the drive's documentation for instructions.

ENSURE THAT YOU HAVE NOT MADE AN ERROR WHILE ENTERING DATA — See the program documentation to make sure that the values or characters you are entering are valid.

CHECK FOR VIRUSES — Use a virus-scanning program to check the hard drive, floppy disks, or CDs.

RESTART THE COMPUTER — Save and close any open files, exit any open programs, and then shut down your computer through the **Start** menu instead of pressing the power button. Otherwise, you may lose data.

CHECK FOR COMPATIBILITY —

- Ensure that the program is compatible with the operating system installed on your computer and that your computer meets the minimum hardware requirements needed to run the software. See the software documentation for information.
- If necessary, uninstall and then reinstall the program.

ENSURE THAT YOU PROPERLY INSTALLED AND CONFIGURED THE PROGRAM — See the software documentation for information. If necessary, uninstall and then reinstall the program.

Other technical problems

GO TO THE DELL SUPPORT WEBSITE — Go to support.dell.com for help with general usage, installation, and troubleshooting questions. The support website offers several different tools to help you, such as Dell Forum—a chat room where you can communicate with other Dell customers about their computers and gain access to technical support through e-mail. See "Dell Support Website" for more information about the website (see page 16). See "Dell Technical Support Policy (U.S. Only)" on page 99 for a description of the hardware and software support provided by Dell.

CALL DELL — If you cannot solve your problem using the Dell Support website or e-mail service, call Dell for technical assistance (see page 100). See "Dell Technical Support Policy (U.S. Only)" on page 99 for a description of the hardware and software support provided by Dell.

General hardware problems

If your computer exhibits one or more of the following symptoms, a device conflict may exist:

- Your computer locks up, particularly while using a specific device.
- A recently added device does not work.
- A sound card emits noise or demonstrates other problems.

- Unintelligible characters print from the printer.
- The mouse pointer does not move or "stutters" when it moves.
- Messages appear stating that the computer is not operating at maximum performance.
- Errors occur and programs crash for no apparent reason.
- Nothing displays on the monitor.

REMOVE ANY RECENTLY ADDED HARDWARE TO SEE IF IT RESOLVES THE CONFLICT — If removing the hardware resolves the conflict, see the hardware documentation for configuration and troubleshooting instructions. If the problem persists, contact the hardware manufacturer for technical assistance.

CHECK YOUR OPERATING SYSTEM DOCUMENTATION FOR ADDITIONAL TROUBLESHOOTING INFORMATION

CHECK FOR INTERRUPT REQUEST CONFLICTS — See page 63.

Keyboard Problems

RESTART THE COMPUTER —

- If the mouse is functioning, shut down the computer through the **Start** menu (see page 30). After the computer shuts down, press the power button to restart the computer.
- If the computer does not respond to a keystroke or the mouse, press the power button for at least 8 to 10 seconds until the computer turns off. Press the power button again to restart the computer.

CHECK THE KEYBOARD CABLE —

- Ensure that the keyboard cable is firmly connected to the computer.
- Shut down the computer (see page 30), reconnect the keyboard cable as shown on the setup diagram for your computer, and then restart the computer.
- Ensure that the keyboard cable is firmly connected to the computer.
- Check the cable connector for bent or broken pins and for damaged or frayed cables. Straighten bent pins.
- Remove keyboard extension cables and connect the keyboard directly to the computer.

TEST THE KEYBOARD — Connect a properly working keyboard to the computer, and try using the keyboard. If the new keyboard works, the original keyboard is faulty.

CHECK FOR INTERRUPT REQUEST CONFLICTS — See page 63.

Mouse Problems

RESTART THE COMPUTER —

- 1 Simultaneously press <Ctrl><Esc> to display the **Start** menu.
- 2 Type u, press the keyboard arrow keys to highlight **Shut down** or **Turn Off**, and then press <Enter>.
- 3 After the computer turns off, press the power button to restart the computer.

RECONNECT THE MOUSE CABLE —

- 1 Simultaneously press <Ctrl><Esc> to display the **Start** menu.
- 2 Type u, press the keyboard arrow keys to highlight **Shut down** or **Turn Off**, and then press <Enter>.
- 3 After the computer turns off, reconnect the mouse cable as shown on the setup diagram for your computer.
- 4 Start the computer.

CHECK THE MOUSE CABLE —

- Check the cable connector for bent or broken pins and for damaged or frayed cables. Straighten bent pins.
- Ensure that the cable is firmly connected to the computer.

TEST THE MOUSE — Connect a properly working mouse to the computer, and try using the mouse. If the new mouse works, the original mouse was faulty.

CHECK THE MOUSE SETTINGS —

- 1 Click the **Start** button, click **Control Panel**, and then click **Printers and Other Hardware**.
- 2 Click **Mouse**.
- 3 Try adjusting the settings.

REINSTALL THE MOUSE DRIVER — See page 60.

CHECK FOR INTERRUPT REQUEST CONFLICTS — See page 63.

Network Problems

CHECK THE NETWORK CABLE CONNECTOR — Ensure that the network cable is connected as shown on page 23.

CHECK THE NETWORK LIGHTS ON THE BACK OF THE COMPUTER — No light indicates that there is no network communication. Try replacing the network cable.

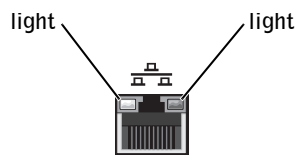

RESTART THE COMPUTER AND TRY TO LOG ON TO THE NETWORK AGAIN

CHECK YOUR NETWORK SETTINGS — Contact your network administrator or the person who set up your network to verify that your network settings are correct and that the network is functioning.

CHECK FOR INTERRUPT REQUEST CONFLICTS — See page 63.

Power Problems

CAUTION: Before you begin any of the procedures in this section, follow the safety instructions on page 9.

ADJUST THE POWER PROPERTIES — Your computer may be in standby or hibernate mode. For information on power conservation modes, see the *Tell Me How* help file, or search for the keyword *standby* or *hibernate* in Windows® Help. To access help files, see page 34.

IF THE POWER LIGHT IS GREEN AND THE COMPUTER IS NOT RESPONDING — See "Diagnostic Lights" on page 54.

IF THE POWER LIGHT IS BLINKING GREEN — The computer is in standby mode. Press a key on the keyboard or move the mouse to resume normal operation.

IF THE POWER LIGHT IS OFF — The computer is either turned off or is not receiving power.

- Reseat the power cable into both the power connector on the back of the computer and the electrical outlet.
- If the computer is plugged into a power strip, ensure that the power strip is plugged into an electrical outlet and that the power strip is turned on.
- Ensure that the electrical outlet is working by testing it with another device, such as a lamp.
- Bypass power protection devices, power strips, and power extension cables to verify that the computer turns on.
- Ensure that the main power cable is securely connected to the system board (see page 74).
- Ensure that the front panel cable is securely connected to the system board (see page 74).
- If the problem persists, contact Dell (see page 100).

ELIMINATE INTERFERENCE — Electrical appliances on the same circuit or operating near the computer can cause interference. Other causes of interference are:

- Power extension cables
- Keyboard and mouse extension cables
- Too many devices on a power strip
- Multiple power strips connected to the same electrical outlet

Printer Problems

 **NOTE:** Dell does not cover the printer's warranty. If you need technical assistance for your printer, call the printer's manufacturer. See the printer documentation for the correct phone number.

CHECK THE PRINTER DOCUMENTATION — See the printer documentation for setup and troubleshooting information.

ENSURE THAT THE PRINTER IS TURNED ON — See the printer documentation for power button information.

VERIFY THE PRINTER CABLE CONNECTIONS —

- See the printer documentation for cable connection information.
- Ensure that the printer cables are securely connected to the printer and the computer as described in "Setting Up a Printer" on page 20.

TEST THE ELECTRICAL OUTLET — Ensure that the electrical outlet is working by testing it with another device, such as a lamp.

VERIFY THAT THE PRINTER IS RECOGNIZED BY WINDOWS® —

- 1 Click the Start button.
- 2 Click Control Panel.
- 3 Click Printers and Other Hardware.
- 4 Click View installed printers or fax printers.
If the printer is listed, right-click the printer icon.
- 5 Click Properties, and then select the Ports tab. For a parallel printer, ensure that the **Print to the following port(s)**: setting is LPT1 (Printer Port). For a USB printer, ensure that the **Print to the following port(s)**: setting is USB.

REINSTALL THE PRINTER DRIVER — See the printer documentation for instructions.

Scanner Problems

 **NOTE:** Dell does not cover the scanner's warranty. If you need technical assistance for your scanner, call the scanner's manufacturer. See the scanner documentation for the correct phone number.

CHECK THE SCANNER DOCUMENTATION — See the scanner documentation for setup and troubleshooting information.

UNLOCK THE SCANNER — Ensure that your scanner is unlocked if it has a locking tab or button.

RESTART THE COMPUTER AND TRY THE SCANNER AGAIN

CHECK THE CABLE CONNECTIONS —

- If your scanner has a power cable, ensure that the power cable is firmly connected to a working electrical outlet and that the scanner is turned on.
- Ensure that the scanner cable is firmly connected to the computer and to the scanner.

VERIFY THAT THE SCANNER IS RECOGNIZED BY MICROSOFT® WINDOWS® —

- 1 Click the Start button.
 - 2 Click Control Panel.
 - 3 Click Printers and Other Hardware.
 - 4 Click Scanners and Cameras.
- If your scanner is listed, Windows recognizes the scanner.

REINSTALL THE SCANNER DRIVER — See the scanner documentation for instructions.

Sound and Speaker Problems

No sound from speakers

 **NOTE:** The volume control in some MP3 players overrides the Windows® volume setting. If you have been listening to MP3 songs, ensure that you did not turn the player volume down or off.

CHECK THE SPEAKER CABLE CONNECTIONS — Ensure that the speakers are connected as shown on the setup diagram supplied with the speakers.

ENSURE THAT THE SUBWOOFER AND THE SPEAKERS ARE TURNED ON — See the setup diagram supplied with the speakers. If your speakers have volume controls, adjust the volume, bass, or treble to eliminate distortion.

ADJUST THE WINDOWS VOLUME CONTROL — Click or double-click the speaker icon in the lower-right corner of your screen. Ensure that the volume is turned up and that the sound is not muted.

DISCONNECT HEADPHONES FROM THE HEADPHONE CONNECTOR — Sound from the speakers is automatically disabled when headphones are connected to the computer's front-panel headphone connector.

TEST THE ELECTRICAL OUTLET — Ensure that the electrical outlet is working by testing it with another device, such as a lamp.

ENABLE DIGITAL MODE — Your speakers do not work if the CD drive is operating in analog mode. To enable digital mode:

- 1 Click the **Start** button, click **Control Panel**, and then click **Sounds, Speech, and Audio Devices**.
- 2 Click **Sounds and Audio Devices**.
- 3 Click the **Hardware** tab.
- 4 Double-click the name of your CD drive.
- 5 Click the **Properties** tab.
- 6 Check the **Enable digital CD audio for this CD-ROM device** box.

ELIMINATE POSSIBLE INTERFERENCE — Turn off nearby fans, fluorescent lights, or halogen lamps to check for interference.

RUN THE SPEAKER DIAGNOSTICS — Some speaker systems have self- diagnostics. See the speaker documentation for diagnostics instructions.

REINSTALL THE AUDIO (SOUND) DRIVER — See page 60.

CHECK FOR INTERRUPT REQUEST CONFLICTS — See page 63.

No sound from headphones

CHECK THE HEADPHONE CABLE CONNECTION — Ensure that the headphone cable is securely inserted into the headphone connector (see page 68).

ADJUST THE WINDOWS VOLUME CONTROL — Click or double-click the speaker icon in the lower-right corner of your screen. Ensure that the volume is turned up and that the sound is not muted.

DISABLE DIGITAL MODE — Your headphones do not work if the CD drive is operating in digital mode. To disable digital mode:

- 1 Click the **Start** button, click **Control Panel**, and then click **Sounds, Speech, and Audio Devices**.
- 2 Click **Sounds and Audio Devices**.
- 3 Click the **Hardware** tab.
- 4 Double-click the name of your CD drive.
- 5 Click the **Properties** tab.
- 6 Uncheck the **Enable digital CD audio for this CD-ROM device** box.

Video and Monitor Problems

If the screen is blank



NOTE: See the monitor documentation for troubleshooting procedures.

CHECK THE MONITOR POWER LIGHT — If the power light is off, firmly press the button to ensure that the monitor is turned on. If the power light is lit or blinking, the monitor has power. If the power light is blinking, press a key on the keyboard or move the mouse.

CHECK THE MONITOR CABLE CONNECTION — Check the connector for bent or broken pins. (It is normal for monitor cable connectors to have missing pins.) Ensure that the video cable is connected as shown on the setup diagram for your computer.

TEST THE ELECTRICAL OUTLET — Ensure that the electrical outlet is working by testing it with another device, such as a lamp.

SWAP THE POWER CABLES — Swap the computer and monitor power cables to determine if the power cable is defective.

TEST THE VIDEO EXTENSION CABLE (IF USED) — If you are using a video extension cable and removing the cable solves the problem, the cable is defective.

TEST ANOTHER MONITOR — If another monitor is available, connect it to the computer.

CHECK THE DIAGNOSTIC LIGHTS — See page 54.

If the screen is difficult to read

CHECK THE MONITOR SETTINGS — See the monitor documentation for instructions on adjusting the contrast and brightness, demagnetizing (degaussing) the monitor, and running the monitor self-test.

MOVE THE SUBWOOFER AWAY FROM THE MONITOR — If your speaker system includes a subwoofer, ensure that the subwoofer is at least 60 cm (2 ft) away from the monitor.

MOVE THE MONITOR AWAY FROM EXTERNAL POWER SOURCES — Fans, fluorescent lights, halogen lamps, and other electrical devices can cause the screen image to appear "shaky." Turn off nearby devices to check for interference.

ROTATE THE MONITOR TO FACE A DIFFERENT DIRECTION — Eliminate sunlight glare, which can cause poor picture quality.

ADJUST THE WINDOWS® DISPLAY SETTINGS —

- 1 Click the **Start** button, and then click **Control Panel**.
- 2 Click **Appearance and Themes**.
- 3 Click **Display**, and then click the **Settings** tab.
- 4 Try different settings for **Screen resolution** and **Color quality**.

RESTORE THE RECOMMENDED SETTINGS — Restore the original resolution and refresh rate settings. See the *Tell Me How* help file for instructions. To access help files, see page 34.

3

SECTION 3

Advanced Troubleshooting

Diagnostic Lights

Dell Diagnostics

Drivers

Using System Restore

Resolving Software and Hardware Incompatibilities

Reinstalling Microsoft® Windows® XP

Diagnostic Lights

To help you troubleshoot a problem, your computer is equipped with four lights on the back panel labeled "A," "B," "C," and "D" (see page 70). These lights can be yellow or green.

When the computer starts normally, the lights flash. After the computer starts, the lights remain green. If the computer malfunctions, the color and sequence of the lights identify the problem.

⚠ CAUTION: Before you begin any of the procedures in this section, follow the safety instructions on page 12.

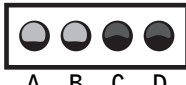
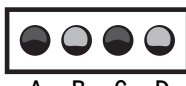
Light Pattern	Problem Description	Suggested Resolution
<p>Y Y G G</p>  <p>A B C D</p>	<p>Memory modules are detected, but a memory failure has occurred.</p>	<ul style="list-style-type: none"> • If you have one memory module installed, reinstall it (see page 83) and restart the computer. • If you have two or more memory modules installed, remove the modules, reinstall one module (see page 83), and then restart the computer. If the computer starts normally, reinstall an additional module. Continue until you have identified a faulty connector or reinstalled all modules without error. • If available, install properly working memory of the same type into your computer (see page 83). • If the problem persists, contact Dell (see page 100).
<p>G Y G Y</p>  <p>A B C D</p>	<p>Memory modules are detected, but a memory configuration or compatibility error exists.</p>	<ul style="list-style-type: none"> • Ensure that there are no special memory module/memory connector placement requirements (see page 83). • Verify that the memory modules that you are installing are compatible with your computer (see page 93). • If the problem persists, contact Dell (see page 100).

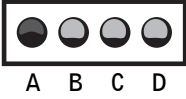
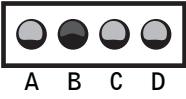
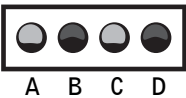
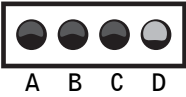
Light Pattern	Problem Description	Suggested Resolution
<p>G Y Y Y</p>  <p>A B C D</p>	No memory modules are detected.	<ul style="list-style-type: none"> Reinstall all memory modules (see page 83) and restart the computer. To eliminate the possibility of a faulty memory connector, remove all memory modules, reinstall one memory module (if the computer supports a single module) (see page 83), and then restart the computer. If the computer starts normally, move the memory module to a different connector and restart the computer. Continue until you have identified a faulty connector or reinstalled all modules without error. If the problem persists, contact Dell (see page 100).
<p>Y G Y Y</p>  <p>A B C D</p>	A PCI bus failure has occurred.	<ol style="list-style-type: none"> Determine if a conflict exists by removing a card (see page 75) and then restarting the computer. If the problem persists, reinstall the card that you removed (see page 75), remove a different card, and then restart the computer. Repeat this process for each card. If the computer starts normally, troubleshoot the last card removed from the computer for resource conflicts (see "Resolving Software and Hardware Incompatibilities" on page 63). If the problem persists, contact Dell (see page 100).
<p>Y G Y G</p>  <p>A B C D</p>	A video controller failure has occurred.	Contact Dell (see page 100).
<p>G G G Y</p>  <p>A B C D</p>	Other failure has occurred.	<ul style="list-style-type: none"> Ensure that the cables are properly connected from the hard drive, CD drive, and DVD drive to the system board (see page 74). If the problem persists, contact Dell (see page 100).

Dell Diagnostics

When to Use the Dell Diagnostics

If you experience a problem with your computer, perform the checks in "Solving Problems" (see page 31) and run the Dell Diagnostics before you contact Dell for technical assistance. Running the Dell Diagnostics may help you resolve the problem without contacting Dell. If you do contact Dell, the test results can provide important information for Dell's service and support personnel.

The Dell Diagnostics allows you to:

- Perform express, extended, or custom tests on one or all devices.
- Select tests based on a symptom of the problem you are having.
- Choose how many times a test is run.
- Display test results.
- Suspend testing if an error is detected.
- Access online help information that describes the tests and devices.
- Receive status messages that tell you whether tests completed successfully.
- Receive error messages if problems are detected.

Starting the Dell Diagnostics



NOTICE: Only use the Dell Diagnostics to test your Dell™ computer. Using this program with other computers can result in error messages.

Start the Dell Diagnostics from either your hard drive or from the *Dell Dimension ResourceCD* as explained in the following sections).

Starting the Dell Diagnostics From Your Hard Drive

- 1 Shut down and restart the computer.
- 2 When the DELL® logo appears, press <F12> immediately.



NOTE: If you receive a message stating that no Diagnostics utility partition has been found, follow the instructions to run the Dell Diagnostics from your ResourceCD.

If you wait too long and the Microsoft® Windows® logo appears, continue to wait until you see the Windows desktop. Then shut down your computer through the **Start** menu and try again.

- 3 When the boot device list appears, highlight **Boot to Utility Partition** and press <Enter>.
- 4 When the Dell Diagnostics Main Menu appears, select the test you want to run (see page 57).

Starting the Dell Diagnostics From the ResourceCD

- 1 Insert the ResourceCD into the CD drive.
- 2 Shut down and restart the computer.

When the DELL® logo appears, press <F12> immediately.

If you wait too long and the Windows logo appears, continue to wait until you see the Windows desktop. Then shut down your computer through the **Start** menu and try again.

 **NOTE:** This feature changes the boot sequence for one time only. On the next start-up, the computer boots according to the devices specified in the system setup program.

- 3 When the boot device list appears, highlight **IDE CD-ROM Device** and press <Enter>.
- 4 Select the **IDE CD-ROM Device** option from the CD boot menu.
- 5 Select the **Boot from CD-ROM** option from the menu that appears.
- 6 Type 1 to start the ResourceCD menu.
- 7 Type 2 to start the Dell Diagnostics.
- 8 Select **Run the 32 Bit Dell Diagnostics** from the numbered list. If multiple versions are listed, select the version appropriate for your platform.
- 9 When the Dell Diagnostics Main Menu appears, select the test you want to run as explained in the following section.

Dell Diagnostics Main Menu

- 1 After the Dell Diagnostics loads and the **Main Menu** screen appears, click the button for the option you want.

 **NOTE:** The Service Tag number for your computer is located at the top of each test screen.

Option	Function
Express Test	Performs a quick test of devices. This test typically takes 10 to 20 minutes and requires no interaction on your part. Run Express Test first to increase the possibility of tracing the problem quickly.
Extended Test	Performs a thorough check of devices. This test typically takes an hour or more and requires you to answer questions periodically.
Custom Test	Tests a specific device. You can customize the tests you want to run.
Symptom Tree	Lists the most common symptoms encountered and allows you to select a test based on the symptom of the problem you are having.

- If a problem is encountered during a test, a message displaying the error code and a description of the problem appear. Write down the error code and problem description and follow the instructions on the screen.

If you cannot resolve the error condition, contact Dell (see page 100).

- If you run a test from the **Custom Test** or **Symptom Tree** option, click the applicable tab described in the following table for more information.

Tab	Function
Results	Displays the results of the test and any error conditions encountered.
Errors	Displays error conditions encountered, error codes, and problem description.
Help	Describes the test and may indicate requirements for running the test.
Configuration	Displays your hardware configuration for the selected device. The Dell Diagnostics obtains your configuration information for all devices from the system setup program, memory, and various internal tests and displays it in the device list in the left pane of the screen. The device list may not display the names of all the components installed on your computer or all devices attached to your computer.
Parameters	Allows you to customize the test by changing the test settings.

- When the tests are completed, if you are running the Dell Diagnostics from the ResourceCD, remove the CD.
- Close the test screen to return to the **Main Menu** screen. To exit the Dell Diagnostics and restart the computer, close the **Main Menu** screen.

Drivers

What Is a Driver?

A driver is a program that controls a device such as a printer, mouse, or keyboard. All devices require a driver program.

A driver acts like a translator between the device and the programs that use the device. Each device has its own set of specialized commands that only its driver recognizes.

Many drivers, such as the keyboard driver, come with your Microsoft® Windows® operating system. You may need to install drivers if you:

- Upgrade your operating system
- Reinstall your operating system
- Connect or install a new device

If you experience a problem with any device, perform the steps in the following sections to identify whether the driver is the source of your problem and if necessary, to update the driver.

Identifying Drivers

- 1** Click the **Start** button and click **Control Panel**.
- 2** In the **Control Panel** window, under **Pick a Category**, click **Performance and Maintenance**.
- 3** In the **Performance and Maintenance** window, click **System**.
- 4** In the **System Properties** window, click the **Hardware** tab.
- 5** Click **Device Manager**.
- 6** In the **Device Manager** window, scroll down the list to see if any device has an exclamation point (a yellow circle with a [!]) on the device icon.

If an exclamation point is next to the device name, you may need to reinstall the driver or install a new driver.

Reinstalling Drivers

 **NOTICE:** The Dell Support website and your *Dell Dimension ResourceCD* provide approved drivers for Dell™ computers. If you install drivers obtained from other sources, your computer might not work correctly.

Using Windows XP Device Driver Rollback

If a problem occurs on your computer after you install or update a driver, use Windows XP Device Driver Rollback to replace the driver with the previously installed version.

To use Device Driver Rollback:

- 1 Click the **Start** button and click **Control Panel**.
- 2 In the **Control Panel** window, under **Pick a Category**, click **Performance and Maintenance**.
- 3 In the **Performance and Maintenance** window, click **System**.
- 4 In the **System Properties** window, click the **Hardware** tab.
- 5 Click **Device Manager**.
- 6 In the **Device Manager** window, right-click the device for which the new driver was installed and click **Properties**.
- 7 Click the **Drivers** tab.
- 8 Click **Roll Back Driver**.

If Device Driver Rollback does not resolve the problem, then use System Restore (see page 61) to return your computer to the operating state that existed before you installed the new driver.

Using the Dell Dimension ResourceCD

If using Device Driver Rollback or System Restore (see page 61) does not resolve the problem, then reinstall the driver from the *Dell Dimension ResourceCD*:

- 1 With the Windows desktop displayed, insert the ResourceCD into the CD or DVD drive.
If this is your first time to use the ResourceCD, go to step 2. If not, go to step 5.
- 2 When the ResourceCD installation program starts, follow the prompts on the screen.
- 3 When the **InstallShield Wizard Complete** window appears, remove the ResourceCD and click **Finish** to restart the computer.
- 4 When you see the Windows desktop, reinsert the ResourceCD into the CD or DVD drive.

5 At the **Welcome Dell System Owner** screen, click **Next**.

 **NOTE:** The ResourceCD displays drivers only for hardware that came on your computer. If you installed additional hardware, the drivers for the new hardware might not be displayed by the ResourceCD. If those drivers are not displayed, exit the ResourceCD program. For drivers information, see the documentation that came with the device.

A message stating that the ResourceCD is detecting hardware in your computer appears.

The drivers that are used by your computer are automatically displayed in the **My Drivers—The ResourceCD has identified these components in your system** window.

6 Click the driver that you want to reinstall and follow the instructions on the screen.

If a particular driver is not listed, then that driver is not required by your operating system.

Using System Restore

The Microsoft® Windows® XP operating system provides System Restore to allow you to return your computer to an earlier operating state (without affecting data files) if changes to the hardware, software, or other system settings have left the computer in an undesirable operating state. See Windows Help for information on using System Restore. To access Windows Help, see page 34.

 **NOTICE:** Make regular backups of your data files. System Restore does not monitor your data files or recover them.

Creating a Restore Point

- 1 Click the **Start** button and click **Help and Support**.
- 2 Click **System Restore**.
- 3 Follow the instructions on the screen.

Restoring the Computer to an Earlier Operating State

If problems occur after you install a device driver, use Device Driver Rollback (see page 60) to resolve the problem. If that is unsuccessful, then use System Restore.

 **NOTICE:** Before you restore the computer to an earlier operating state, save and close all open files and close all open programs. Do not alter, open, or delete any files or programs until the system restoration is complete.

- 1 Click the **Start** button, point to **All Programs**→**Accessories**→**System Tools**, and then click **System Restore**.
- 2 Ensure that **Restore my computer to an earlier time** is selected and click **Next**.
- 3 Click a calendar date to which you want to restore your computer.

The **Select a Restore Point** screen provides a calendar that allows you to see and select restore points. All calendar dates with available restore points appear in bold.

- 4 Select a restore point and click **Next**.

If a calendar date has only one restore point, then that restore point is automatically selected. If two or more restore points are available, click the restore point that you prefer.

- 5 Click **Next**.

The **Restoration Complete** screen appears after System Restore finishes collecting data and then the computer restarts.

- 6 After the computer restarts, click **OK**.

To change the restore point, you can either repeat the steps using a different restore point, or you can undo the restoration.

Undoing the Last System Restore

 **NOTICE:** Before you undo the last system restore, save and close all open files and close all open programs. Do not alter, open, or delete any files or programs until the system restoration is complete.

- 1 Click the **Start** button, point to **All Programs**→**Accessories**→**System Tools**, and then click **System Restore**.
- 2 Click **Undo my last restoration** and click **Next**.
- 3 Click **Next**.

The **System Restore** screen appears and the computer restarts.

- 4 After the computer restarts, click **OK**.

Enabling System Restore

If you reinstall Windows XP with less than 200 MB of free hard-disk space available, System Restore is automatically disabled. To see if System Restore is enabled:

- 1 Click the **Start** button and click **Control Panel**.
- 2 Click **Performance and Maintenance**.

- 3 Click **System**.
- 4 Click the **System Restore** tab.
- 5 Ensure that **Turn off System Restore** is unchecked.

Resolving Software and Hardware Incompatibilities

Windows XP IRQ conflicts occur if a device either is not detected during the operating system setup or is detected but incorrectly configured.

To check for conflicts on a computer running Windows XP:

- 1 Click the **Start** button and click **Control Panel**.
- 2 Click **Performance and Maintenance** and click **System**.
- 3 Click the **Hardware** tab and click **Device Manager**.
- 4 In the **Device Manager** list, check for conflicts with the other devices.
Conflicts are indicated by a yellow exclamation point (!) beside the conflicting device or a red X if the device has been disabled.
- 5 Double-click any conflict to display the **Properties** window.
If an IRQ conflict exists, the **Device** status area in the **Properties** window reports the cards or devices that share the device's IRQ.
- 6 Resolve conflicts by reconfiguring the devices or removing the devices from the **Device Manager**.

To use the Windows XP Hardware Troubleshooter:

- 1 Click the **Start** button and click **Help and Support**.
- 2 Type `hardware troubleshooter` in the **Search** field and click the arrow to start the search.
- 3 Click **Hardware Troubleshooter** in the **Search Results** list.
- 4 In the **Hardware Troubleshooter** list, click **I need to resolve a hardware conflict on my computer**, and click **Next**.

Reinstalling Microsoft® Windows® XP

Before You Reinstall

If you are reinstalling the Windows XP operating system to correct a problem with a newly installed driver, use Windows XP Device Driver Rollback (see page 60) to replace the device driver with the previously installed version.

If Device Driver Rollback does not resolve the problem, then use System Restore (see page 61) to return your operating system to the operating state it was in before you installed the new device driver.

Reinstalling Windows XP

To reinstall Windows XP, perform the steps in the following sections in the order in which they are listed.

The reinstallation process can take 1 to 2 hours to complete. After the reinstallation is complete, you need to reinstall the device drivers, virus protection program, and other software.

 **NOTICE:** The *Operating System* CD provides options for reinstalling Windows XP. The options can overwrite files and possibly affect programs installed on your hard drive. Therefore, do not reinstall Windows XP unless instructed to do so by a Dell technical support representative.

 **NOTICE:** To prevent conflicts with Windows XP, disable any virus protection software installed on your computer before you reinstall Windows XP. See the documentation that came with the software for instructions.

Preparing to Boot From the Operating System CD

- 1 Insert the *Operating System* CD into the CD or DVD drive.
- 2 Exit any program or utility that might run after you insert the CD.
- 3 Shut down (see page 30) and restart the computer.
- 4 Press <F12> immediately after the DELL™ logo appears.
If the operating system logo appears, wait until you see the Windows desktop, and then shut down the computer and try again.
- 5 Use the arrow keys to select CD-ROM and press <Enter>.
- 6 When the Press any key to boot from CD message appears on the screen, press any key.

Starting Windows XP Setup

- 1 When the **Windows XP Setup** screen appears, press <Enter> to select **To set up Windows now**.
- 2 Read the information in the **Microsoft Windows Licensing Agreement** screen, and then press <F8> to accept the license agreement.
- 3 If your computer already has Windows XP installed and you want to recover your current Windows XP data, type *r* to select the repair option, and then remove the CD from the drive.
- 4 If you want to install a new copy of Windows XP, press <Esc> to select the fresh copy option.
- 5 Press <Enter> to select the highlighted partition (recommended), and then follow the instructions on the screen.



NOTE: The time required to complete the setup depends on the size of the hard drive and the speed of your computer.

The **Windows XP Setup** screen appears, and the operating system begins to copy files and install the devices. The computer restarts multiple times.

Completing the GUI Setup



NOTICE: When the computer restarts, the following message appears: *Press any key to boot from the CD. Do not press any key when this message appears.*

- 1 When the **Regional and Language Options** screen appears, select the settings for your location and click **Next**.
- 2 Enter your name and organization (optional) in the **Personalize Your Software** screen and click **Next**.
- 3 *If you are reinstalling Windows XP Home Edition*, at the **What's your computer's name** window, enter a name for your computer (or accept the name provided) and click **Next**.
If you are reinstalling Windows XP Professional, at the **Computer Name and Administrator Password** window, enter a name for your computer (or accept the one provided) and a password, and then click **Next**.
- 4 If you have a modem installed, enter the requested information and click **Next** when the **Modem Dialing Information** screen appears.
- 5 Enter the date, time, and time zone in the **Date and Time Settings** window and click **Next**.
- 6 Click **Typical** in the **Networking Settings** screen and click **Next**.

- 7 If you are reinstalling Windows XP Professional, you may be prompted to provide further network information regarding your network configuration, such as the domain name or workgroup name. If you are unsure of your settings, accept the default selections.

Windows XP installs the operating system components, configures the computer, and then restarts the computer.

Completing the Operating System Setup

 **NOTICE:** When the computer restarts, the following message appears: Press any key to boot from the CD. *Do not* press any key when this message appears.

- 1 When the **Welcome to Microsoft** screen appears, click **Next**.
- 2 When the **How will this computer connect to the Internet?** message appears, click **Skip**.
- 3 When the **Ready to register with Microsoft?** screen appears, click **No, not at this time** and click **Next**.

When the **Who will use this computer?** screen appears, you can enter up to five users.

- 4 Click **Next**.
- 5 Click **Finish** to complete the setup and remove the CD from the drive.

Reinstalling Drivers and Software

- 1 Reinstall the appropriate drivers (see page 60).
- 2 Reinstall your virus protection software. See the documentation that came with the software for instructions.
- 3 Reinstall your other software programs. See the documentation that came with the software for instructions.

4

SECTION 4

Adding Parts

Front and Back View of the Computer

Removing the Computer Cover

Looking Inside Your Computer

Adding Cards

Adding a Second CD or DVD Drive

Adding Memory

Adding a Floppy Drive

Replacing the Computer Cover

Front and Back View of the Computer

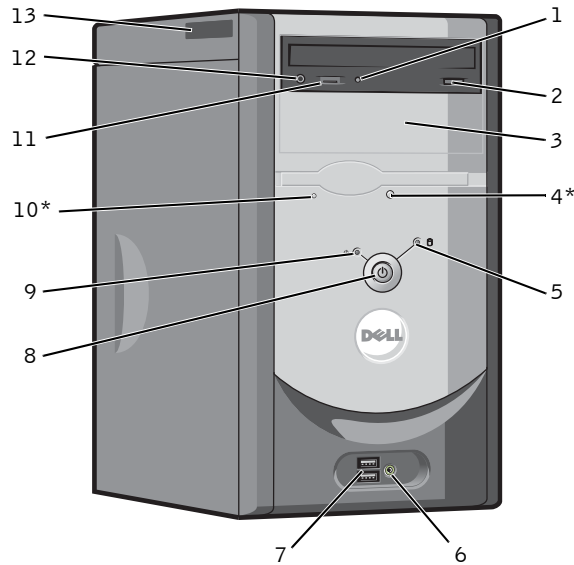

Front View



*On computers with an optional floppy drive.

1	CD or DVD drive activity light	The drive activity light is on when the computer reads data from the CD or DVD drive.
2	CD or DVD eject button	Press this button to eject your CD from the CD or DVD drive.
3	second drive bay	This bay allows an optional second optical drive to be installed into the computer.
4	floppy drive eject button*	Press this button to eject a disk from the floppy drive.
5	hard-drive activity light	The hard-drive light is on when the computer reads data from or writes data to the hard drive. The light might also be on when devices such as your CD player are operating.
6	headphone connector	Use the headphone connector to attach headphones and most speakers for listening to all sounds in your computer, including your CD player and system sounds such as beeps.

*On computers with an optional floppy drive.

7	USB 2.0 connectors (2)	For quick connections, Dell recommends using the front USB connectors for USB devices such as digital cameras, gaming controllers, and scanners. Use the back-panel USB connectors for USB mouse and keyboard connections.
8	power button	Press this button to turn on the computer.  NOTICE: To avoid losing data, do not use the power button to turn off the computer. Instead, perform a Windows shutdown.
9	power light	The power light illuminates and blinks or remains solid to indicate different states: No light — The computer is in the off state. Steady green — The computer is in a normal operating state. Blinking green — The computer is in a power-saving state.
10	floppy-drive light*	The floppy-drive light is on when the computer reads data from or writes data to the floppy drive. Wait until this light turns off before you remove the floppy disk from the drive.
11	CD or DVD volume control dial	Move the dial to adjust the volume of your audio CD or DVD disc.
12	CD or DVD headphone connector	Use the headphone connector to attach headphones to the CD or DVD drive. Your headphones won't work if the drive is operating in digital mode. To disable digital mode, see "No sound from headphones" on page 49.
13	service tag	This label lists your computer's service tag and your Express Service Code (if applicable). If you call Dell technical support, use your Express Service Code to route the call directly to the correct support personnel. The Dell technical support staff will ask for your service tag.  NOTE: Express Service may not be available in some countries.

*On computers with an optional floppy drive.

Back View

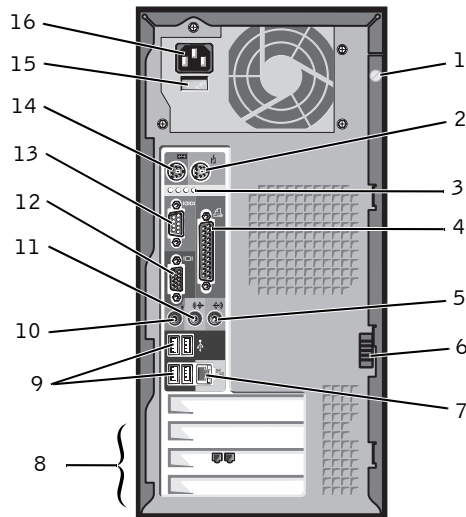

1	cover thumbscrew	Your computer may not have a cover thumbscrew.
2	mouse connector	Plug your computer's PS/2 mouse into the green mouse connector. Turn off the computer and any attached devices before you connect a mouse to the computer. (If you have a USB mouse, see "USB 2.0 connectors" in this table.)
3	diagnostic lights (4)	Use the lights to help you recognize a diagnostic code that can tell you how to troubleshoot a computer problem (see page 54).
4	parallel connector	Connect a parallel device, such as a printer, to the parallel connector. If you have a USB printer, plug it into a USB connector.
5	line-in connector	Use the blue line-in connector to attach a record/playback device such as a cassette player, CD player, or VCR.
6	cover latch	Your computer may not have a cover latch.
7	network adapter connector	Connect a network cable to the network adaptor connector.
8	PCI card slots (3)	Use these slots for a PCI card, such as a modem.
9	USB 2.0 connectors (4)	Connect a USB device such as a mouse, keyboard, printer, joystick, or speaker system into any of the USB connectors.
10	microphone connector	Use the pink microphone connector to attach a personal computer microphone for voice or musical input to a sound or telephony program.

11	line-out connector	Use the green line-out connector to attach headphones and most speakers with integrated amplifiers.
12	video connector	Plug the cable from your monitor into the blue connector.
13	serial connector	Connect a serial device, such as a handheld device, to the serial connector.
14	keyboard connector	Plug your computer's PS/2 keyboard into the purple keyboard connector. Turn off the computer and any attached devices before you connect a keyboard to the computer. (If you have a USB keyboard, see "USB 2.0 connectors" in this table.)
15	voltage selection switch	See the safety instructions on page 11 for more information.
16	power connector	Connect the power cable.

Removing the Computer Cover

 **CAUTION:** Before you begin any of the procedures in this section, follow the safety instructions on page 9.

- 1 Shut down the computer through the **Start** menu (see page 30).
- 2 Ensure that your computer and attached devices are turned off. If your computer and attached devices did not automatically turn off when you shut down your computer, turn them off now.

 **NOTICE:** To disconnect a network cable, first unplug the cable from your computer and then unplug it from the network wall jack.

- 3 Disconnect any telephone or telecommunication lines from the computer.
- 4 Disconnect your computer and all attached devices from their electrical outlets, and then press the power button to ground the system board.

 **CAUTION:** To guard against electrical shock, always unplug your computer from the electrical outlet before opening the cover.

 **NOTICE:** Before touching anything inside your computer, ground yourself by touching an unpainted metal surface, such as the metal at the back of the computer. While you work, periodically touch an unpainted metal surface to dissipate any static electricity that could harm internal components.

- 5 If your computer cover has a thumbscrew, loosen the thumbscrew.
- 6 If your computer cover has a cover latch, push down on the cover latch.

- 7 Grip the indent in the middle of the computer cover, and slide the computer cover towards the back of the computer.

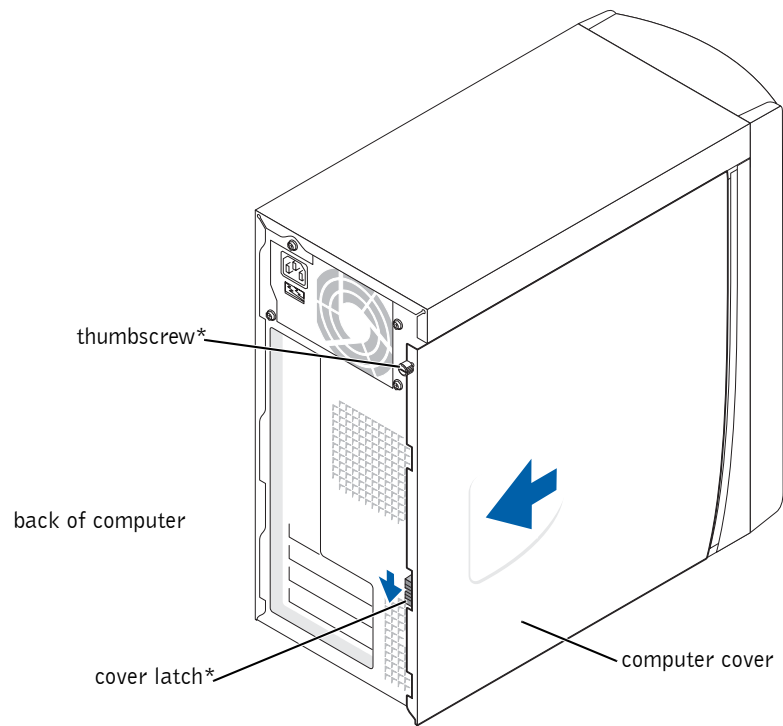

* May not be present on all computer covers.

- 8 Place the computer cover on a level surface.

Looking Inside Your Computer

⚠ CAUTION: Before you begin any of the procedures in this section, follow the safety instructions on page 9.

⚠ CAUTION: To guard against electrical shock, always unplug your computer from the electrical outlet before opening the computer cover.

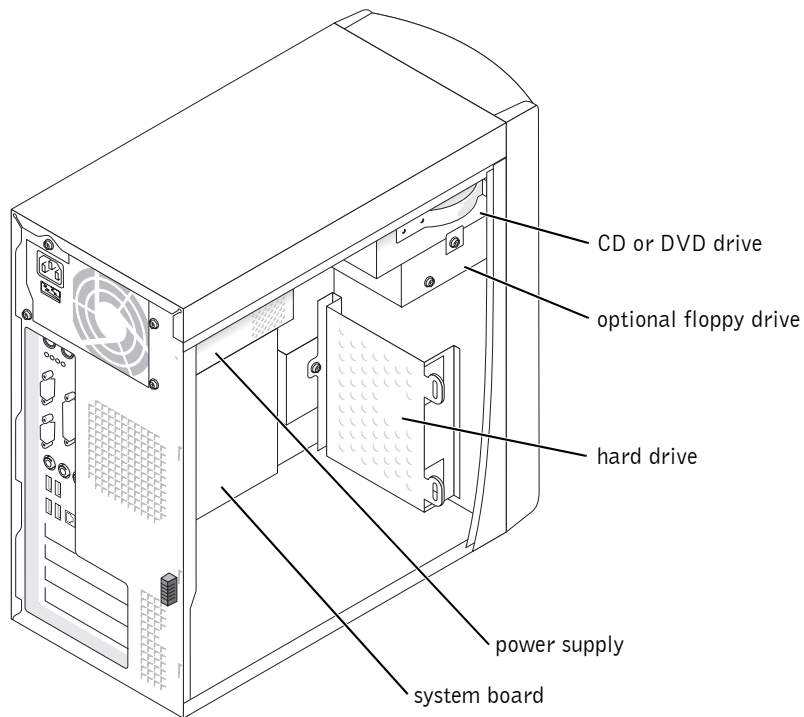

System Board

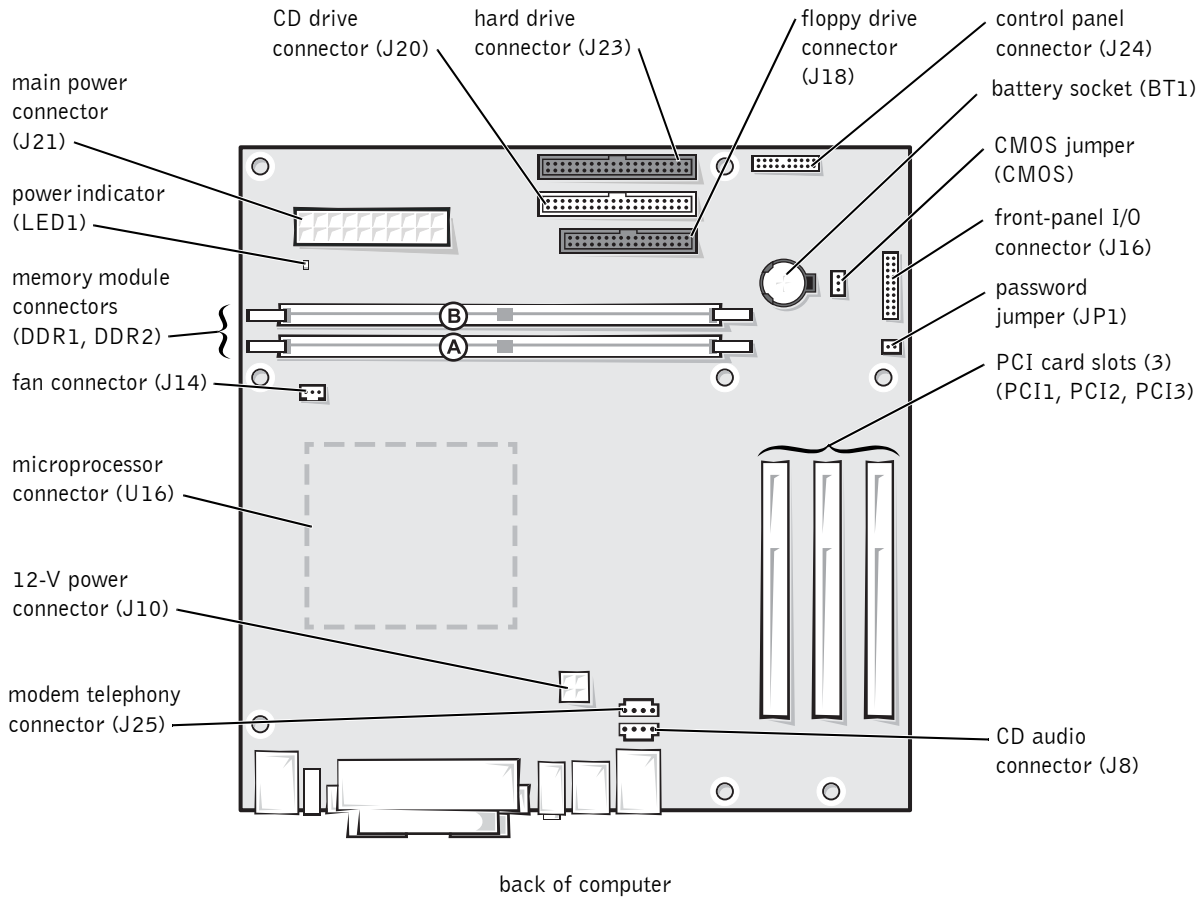

Adding Cards

⚠ CAUTION: Before you begin any of the procedures in this section, follow the safety instructions on page 9.

- 1 Shut down the computer through the **Start** menu (see page 30).
- 2 Ensure that your computer and attached devices are turned off. If your computer and attached devices did not automatically turn off when you shut down your computer, turn them off now.

➡ NOTICE: To disconnect a network cable, first unplug the cable from your computer and then unplug it from the network wall jack.

- 3 Disconnect any telephone or telecommunication lines from the computer.
- 4 Disconnect your computer and all attached devices from their electrical outlets, and then press the power button to ground the system board.

⚠ CAUTION: To guard against electrical shock, always unplug your computer from the electrical outlet before opening the cover.

- 5 Remove the computer cover (see page 71).

➡ NOTICE: Before touching anything inside your computer, ground yourself by touching an unpainted metal surface, such as the metal at the back of the computer. While you work, periodically touch an unpainted metal surface to dissipate any static electricity that could harm internal components.

- 6 Lay the computer on its side so that the system board is on the bottom of the inside of the computer.

- 7 Unscrew and remove the filler bracket for the card slot you want to use.

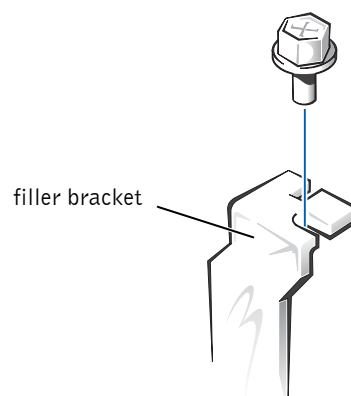

⚠ CAUTION: Some network adapters automatically start the computer when they are connected to a network. To guard against electrical shock, be sure to unplug your computer from its electrical outlet before installing any cards.

- 8 Align the cutout on the bottom of the card with the crossbar in the system board connector. Gently rock the card into the connector until it is fully seated.

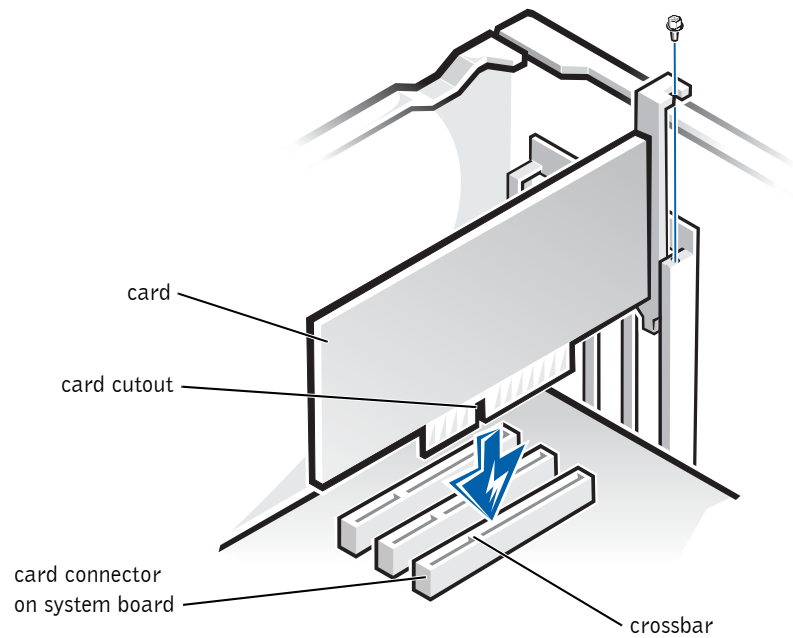

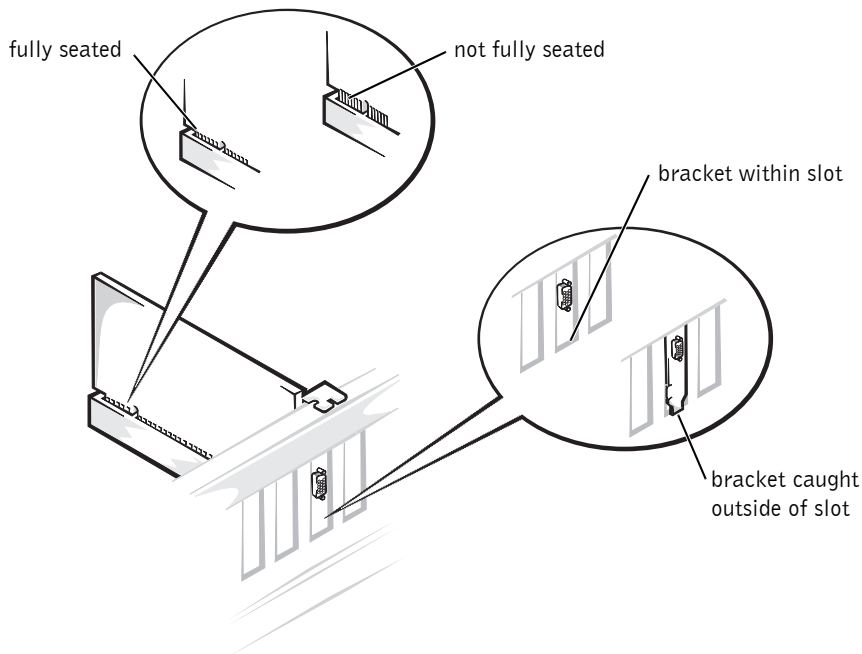

Ensure that the card is fully seated and that its bracket is within the card slot.





- 9 Secure the filler bracket onto the end of the card with the screw you removed in step 7.
- 10 Connect any cables required for the card as described in the card documentation.
- ➔ **NOTICE:** Do not route card cables over or behind the cards. Cables routed over the cards can cause damage to the equipment.
- 11 Replace the computer cover (see page 90).
- ➔ **NOTICE:** To connect a network cable, first plug the cable into the network wall jack and then plug it into the computer.
- 12 Connect your computer and devices to electrical outlets, and turn them on.
- 13 Install any drivers required for the card as described in the card documentation.

Adding a Second CD or DVD Drive

 **CAUTION:** Before you begin any of the procedures in this section, follow the safety instructions on page 9.

 **NOTE:** Drives sold by Dell come with their own operating software and documentation. After you install a drive, see the documentation that came with the drive for instructions on installing and using the drive software.

- 1 Shut down the computer through the **Start** menu (see page 30).
- 2 Ensure that your computer and attached devices are turned off. If your computer and attached devices did not automatically turn off when you shut down your computer, turn them off now.
-  **NOTICE:** To disconnect a network cable, first unplug the cable from your computer and then unplug it from the network wall jack.
- 3 Disconnect any telephone or telecommunication lines from the computer.
- 4 Disconnect your computer and all attached devices from their electrical outlets, and then press the power button to ground the system board.

 **CAUTION:** To guard against electrical shock, always unplug your computer from the electrical outlet before opening the cover.

- 5 Remove the computer cover (see page 71).
-  **NOTICE:** Before touching anything inside your computer, ground yourself by touching an unpainted metal surface, such as the metal at the back of the computer. While you work, periodically touch an unpainted metal surface to dissipate any static electricity that could harm internal components.
- 6 Release and remove the front panel:
 - a Push the release lever to release the top tab.
 - b Reach inside the computer and push the bottom tab towards you to release it (the middle tab releases automatically).
 - c Rotate the front panel to separate it from the side hinges.

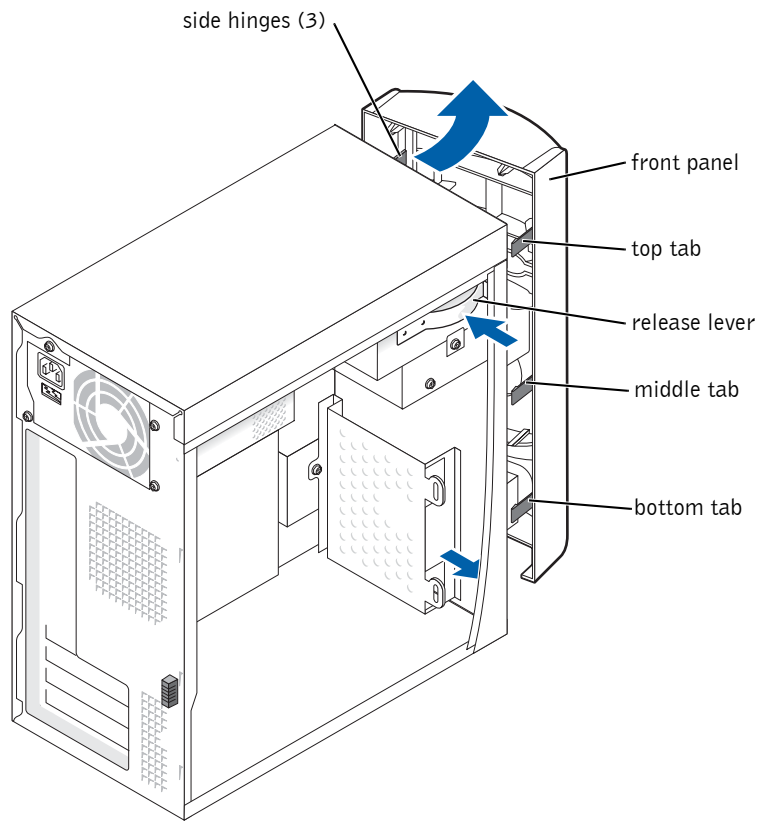

- 7 Pull the two front-panel tabs towards you, and then push out the front-panel insert.

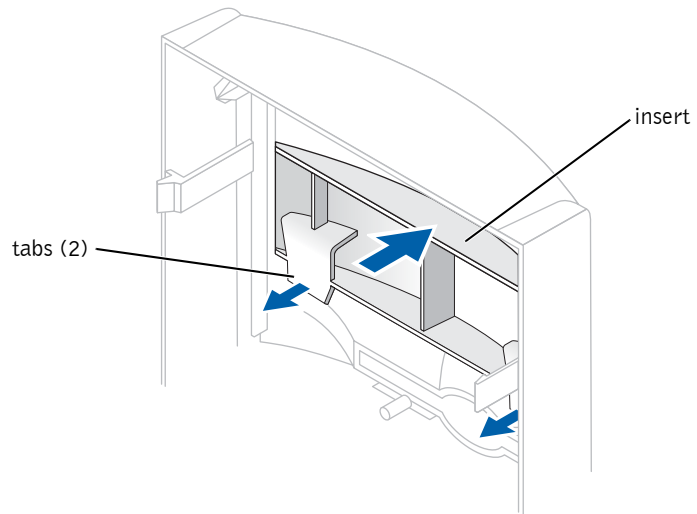

- 8 Ensure that the jumper setting on the new drive is set for "cable select" (see the documentation that came with the drive for information).
- 9 Remove two extra alignment screws, shown in the illustration on page 81, from the front of the computer and insert them into the drive.

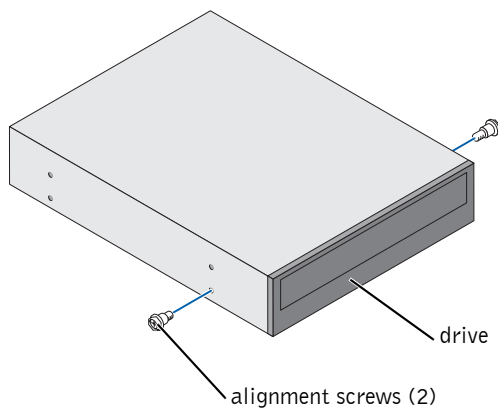

NOTE: Some computers come with only two extra alignment screws; others come with four. You only need two alignment screws for this procedure.

10 Gently slide the drive into place.

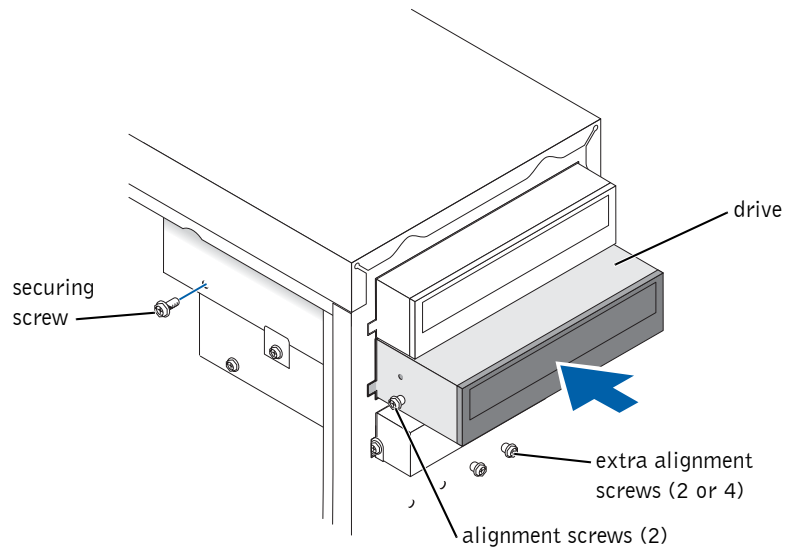

11 Once the drive is in place, apply pressure to ensure that the drive is fully seated.

12 Use the securing screw that came with the drive to attach the drive to the computer.

CAUTION: Match the colored strip on the cable with pin 1 on the drive (pin 1 is marked as "1").

13 Connect the power cable to the system board.

14 Locate the data cable from the CD or DVD drive in the upper drive bay and connect its middle data connector to the new drive.

15 Check all cable connections, and then fold the cables out of the way to provide airflow for the fan and cooling vents.

- 16 Reattach the front panel to the side hinges, and then rotate it until it snaps onto the front of the computer.

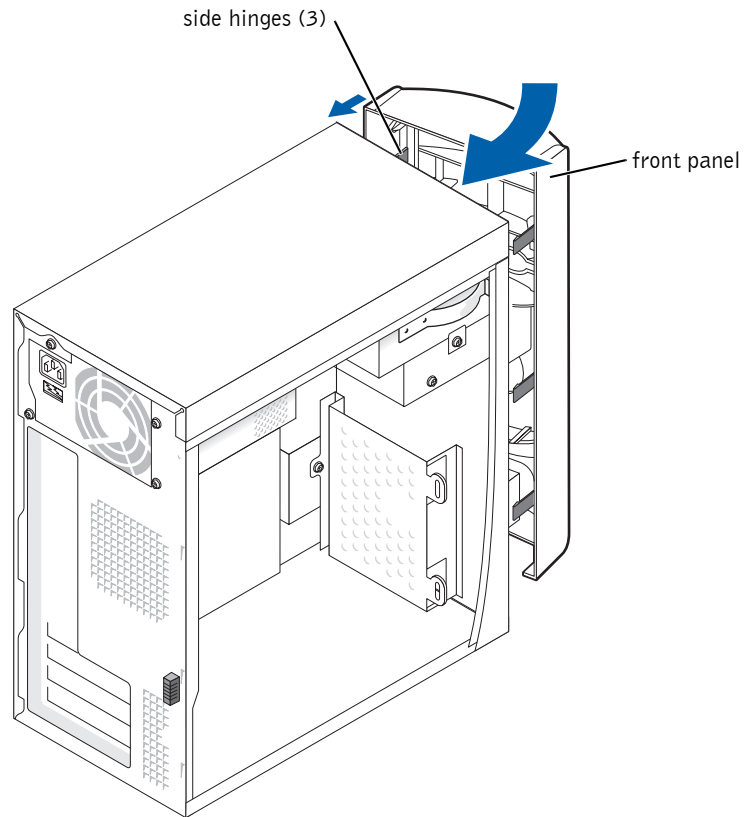

- 17 Replace the computer cover (see page 90).
- ➡ **NOTICE:** To connect a network cable, first plug the cable into the network wall jack and then plug it into the computer.
- 18 Connect your computer and devices to electrical outlets, and then turn them on.
- 19 See the documentation that came with the drive for instructions on installing any software required for drive operation.

Adding Memory

 **NOTE:** Memory purchased from Dell is covered under your computer warranty.

You can increase your computer memory by installing memory modules on the system board. For information on the type of memory supported by your computer, see "Memory" on page 93.

 **CAUTION:** Before you begin any of the procedures in this section, follow the safety instructions on page 9.

- 1 Shut down the computer through the **Start** menu (see page 30).
- 2 Ensure that your computer and attached devices are turned off. If your computer and attached devices did not automatically turn off when you shut down your computer, turn them off now.

 **NOTICE:** To disconnect a network cable, first unplug the cable from your computer and then unplug it from the network wall jack.

- 3 Disconnect any telephone or telecommunication lines from the computer.
- 4 Disconnect your computer and all attached devices from their electrical outlets, and then press the power button to ground the system board.

 **CAUTION:** To guard against electrical shock, always unplug your computer from the electrical outlet before opening the cover.

- 5 Remove the computer cover (see page 71).

 **NOTICE:** Before touching anything inside your computer, ground yourself by touching an unpainted metal surface, such as the metal at the back of the computer. While you work, periodically touch an unpainted metal surface to dissipate any static electricity that could harm internal components.

- 6 Lay the computer on its side so that the system board is on the bottom of the inside of the computer.
- 7 If necessary, remove a memory module:
 - a Press out the securing clip at each end of the memory module connector.
 - b Grasp the module and pull up.

If the module is difficult to remove, gently ease the module back and forth to remove it from the connector.

- 8 To insert a module, press out the securing clip at each end of the memory module connector.

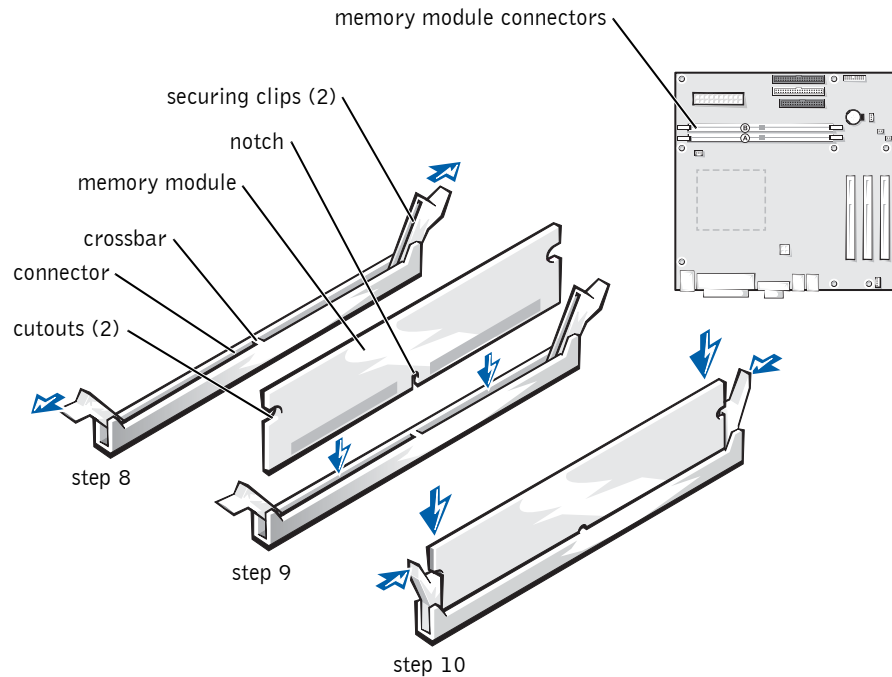

- 9 Align the notch on the bottom of the module with the crossbar in the connector.
- ➔ **NOTICE:** To avoid breaking the memory module, do not press near the middle of the module.
- 10 Insert the module straight down into the connector, ensuring that it fits into the vertical guides at each end of the connector. Press firmly on the ends of the module until it snaps into place.
If you insert the module correctly, the securing clips snap into the cutouts at each end of the module.
- 11 Replace the computer cover (see page 90).
- ➔ **NOTICE:** To connect a network cable, first plug the cable into the network wall jack and then plug it into the computer.
- 12 Connect your computer and devices to electrical outlets, and turn them on.
- 13 Click the **Start** button, right-click **My Computer**, and then click **Properties**.

- 14 Click the **General** tab.
- 15 To verify that the memory is installed correctly, check the amount of memory (RAM) listed.

Adding a Floppy Drive

 **CAUTION:** Before you begin any of the procedures in this section, follow the safety instructions on page 9.

- 1 Shut down the computer through the **Start** menu (see page 30).
- 2 Ensure that your computer and attached devices are turned off. If your computer and attached devices did not automatically turn off when you shut down your computer, turn them off now.

 **NOTICE:** To disconnect a network cable, first unplug the cable from your computer and then unplug it from the network wall jack.

- 3 Disconnect any telephone or telecommunication lines from the computer.
- 4 Disconnect your computer and all attached devices from their electrical outlets, and then press the power button to ground the system board.

 **CAUTION:** To guard against electrical shock, always unplug your computer from the electrical outlet before opening the cover.

- 5 Remove the computer cover (see page 71).

 **NOTICE:** Before touching anything inside your computer, ground yourself by touching an unpainted metal surface, such as the metal at the back of the computer. While you work, periodically touch an unpainted metal surface to dissipate any static electricity that could harm internal components.

- 6 Release and remove the front panel:
 - a Push the release lever to release the top tab.
 - b Reach inside the computer and push the bottom tab towards you to release it (the middle tab releases automatically).
 - c Rotate the front panel to separate it from the side hinges.

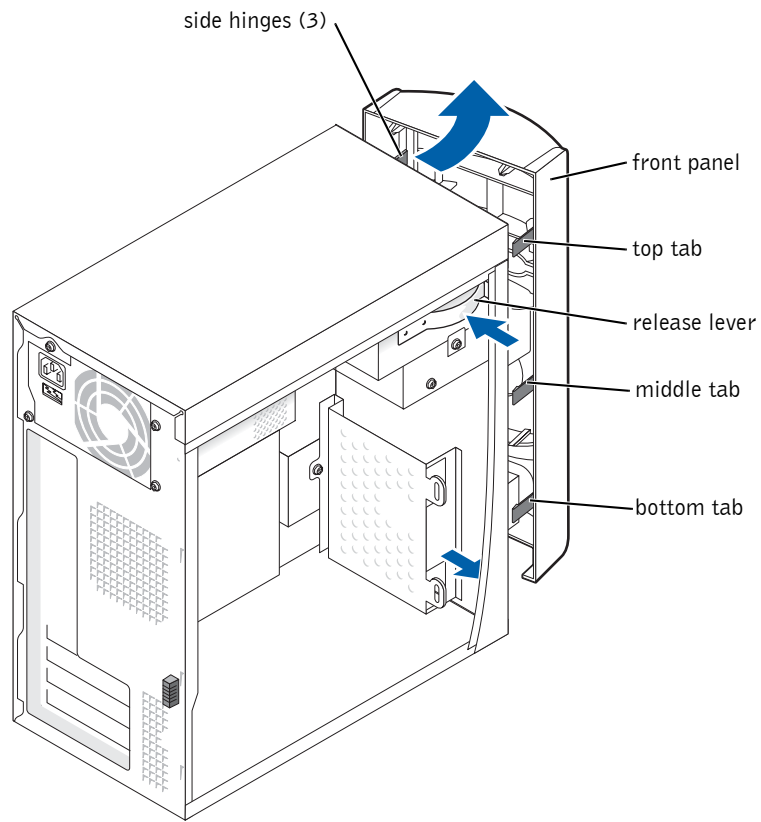

- 7 Press in the two insert tabs, and then push out the front-panel insert.

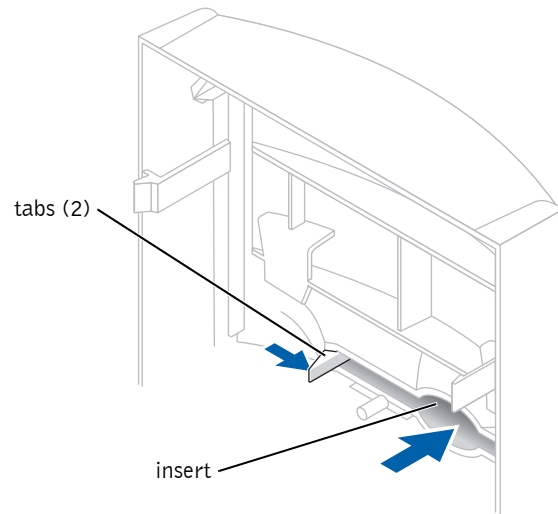

- 8 Connect the floppy-drive power cable to the back of the drive.

➔ CAUTION: Match the colored strip on the cable with pin 1 on the drive (pin 1 is marked as "1").

- 9 Connect the data cable to the back of the drive and to the floppy drive connector on the system board (see page 74).

The data cable is included in the floppy drive kit.

- 10 Position the top of the floppy drive bracket so that it is completely flush with the bottom of the upper drive bay, and then slide the floppy drive bracket forward into place.

The top of the floppy drive bracket has two slots that fit into two clips on the bottom of the upper drive bay. When the floppy drive bracket is properly mounted, it remains in place without support.

- 11 Secure the floppy drive bracket with the top bracket screw that came with the floppy drive kit.

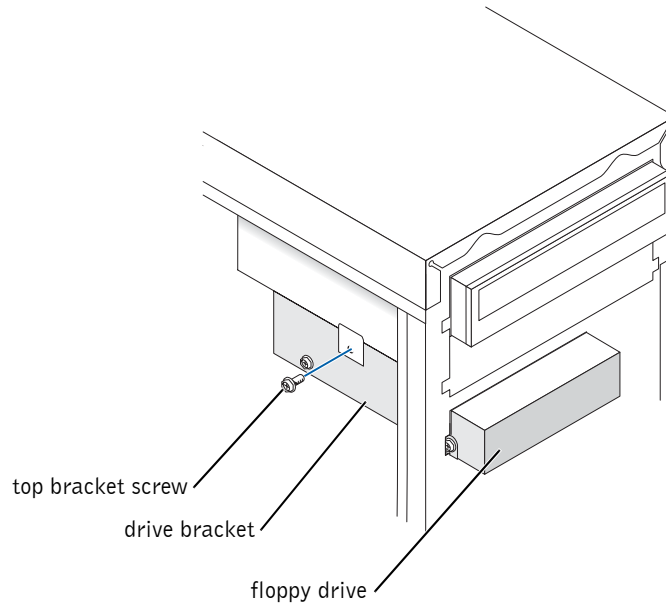

- 12 Reattach the front panel to the side hinges, and then rotate it until it snaps onto the front of the computer.

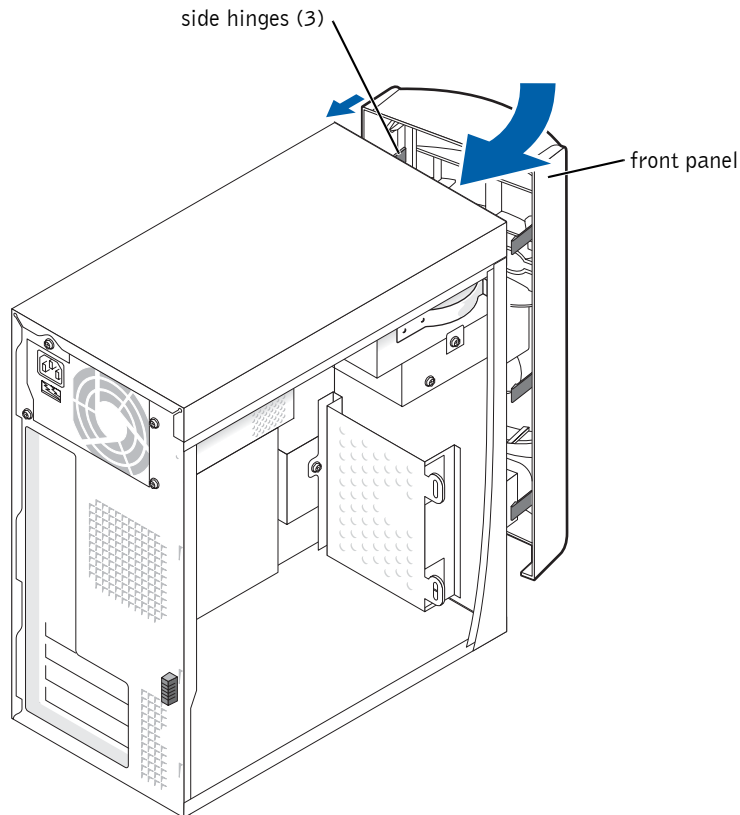

- 13 Check all cable connections, and fold cables out of the way to provide airflow for the fan and cooling vents.
- 14 Replace the computer cover (see page 90).
- ➔ **NOTICE:** To connect a network cable, first plug the cable into the network wall jack and then plug it into the computer.
- 15 Connect your computer and devices to electrical outlets, and turn them on.
- 16 See the documentation that came with the drive for instructions on installing any software required for drive operation.

Use the **Boot** menu options in the system setup program to adjust the boot order of the floppy drive. For more information about the system setup program, see page 95.

Replacing the Computer Cover

- 1 Ensure that all cables are connected, and fold cables out of the way. Also, ensure that cables are not routed over the drive cage—they can prevent the cover from closing properly.
- 2 Ensure that no tools or extra parts are left inside the computer.
- 3 Place the cover on the computer.
- 4 Slide the cover towards the front of the computer until it fits completely into place.
- 5 If your computer has a computer cover thumbscrew, tighten the thumbscrew.
- ➔ **NOTICE:** To connect a network cable, first plug the cable into the network wall jack and then plug it into the computer.
- 6 Connect your computer and devices to electrical outlets and turn them on.

SECTION 5

Appendix

- Specifications
- Standard Settings
- Clearing Forgotten Passwords
- Replacing the Battery
- Dell Technical Support Policy (U.S. Only)
- Contacting Dell
- Regulatory Notices
- Limited Warranties and Return Policy

Specifications

Microprocessor

Microprocessor type	Intel® Pentium® 4 or Celeron®
L1 cache	8 KB first-level (Pentium 4); 32 KB (16-KB data cache; 16-KB instruction cache) (Celeron).
L2 cache	256- or 512-KB (displayed in the system setup program) pipelined-burst, eight-way set associative, write-back SRAM (Pentium 4); 128-KB SRAM that resides in the processor's core. The L2 cache runs at the processor's internal clock speed (Celeron).

System Information

System chip set	Intel 845GL
DMA channels	seven
Interrupt levels	24 APIC mode
System BIOS chip	2 Mb (256 KB)
System clock	400-MHz data rate

Expansion Bus

Bus types	PCI
Bus speed	PCI: 33 MHz
PCI connectors	three
PCI connector size	120 pins
PCI connector data width (maximum)	32 bits

Memory

Architecture	DDR SDRAM
Memory connectors	two
Memory capacities	128-, 256-, or 512-MB
Minimum memory	128 MB shared DDR SDRAM <i>NOTE: Between 32 and 64 MB of system memory may be allocated to support graphics, depending on system memory size and other factors.</i>
Maximum memory	1 GB
Memory type	PC2100 (266-MHz) DDR SDRAM (non-ECC)

Drives

Externally accessible	two 5.25-inch bays one 3.5-inch bay
Internally accessible	one bay for 1-inch-high IDE hard drive

Ports and Connectors

Externally accessible:	
Serial	9-pin connector; 16550C-compatible
Parallel	25-hole connector (bidirectional)
Video	15-hole connector
Keyboard	6-pin mini-DIN connector
Mouse	6-pin mini-DIN connector
USB	two front-panel and four back-panel USB 2.0-compliant connectors
Network	RJ-45 connector
Audio	three back miniature connectors for line-in, line-out, and microphone
Headphone	one front miniature connector for line-out
Internally accessible:	
Primary IDE channel	40-pin connector on PCI local bus
Secondary IDE channel	40-pin connector on PCI local bus
Floppy drive	34-pin connector

Video

Video controller	integrated Intel 3D Extreme Graphics
------------------	--------------------------------------

Audio

Audio controller	integrated audio
------------------	------------------

Network

Network controller	integrated 10/100 Ethernet
--------------------	----------------------------

Controls and Lights

Power control	push button
Front-panel power light	solid green for power-on state; blinking green for standby state
Hard-drive access light	green

Power

DC power supply:	
Wattage	200 W or 250 W
Heat dissipation	682 or 853 BTU (fully-loaded computer without monitor)
Voltage (see page 11 for important voltage setting information)	100 to 120 V at 60 Hz; 200 to 240 V at 50 Hz
Backup battery	3-V CR2032 coin cell

Physical

Height x Width x Depth	36.8 x 18.4 x 42.6 cm (14.5 x 7.25 x 16.75 inches)
Weight	10.4 kg (23 lb)

Environmental

Temperature:	
Operating	10° to 35°C (50° to 95°F) <i>NOTE: At 35°C (95°F), the maximum operating altitude is 914 m (3000 ft).</i>
Storage	-40° to 65°C (-40° to 149°F)

Environmental (continued)

Relative humidity	20% to 80% (noncondensing)
Maximum vibration:	
Operating	0.25 G at 3 to 200 Hz
Storage	2.20 Grms at 10 to 500 Hz
Maximum shock:	
Nonoperating (half-sine pulse)	105 G, 2 ms
Nonoperating (faired-square wave)	32 G with a velocity change of 596.9 cm/sec (235 inches/sec)
Altitude:	
Operating	-15.2 to 3048 m (-50 to 10,000 ft) <i>NOTE: At 35°C (95°F), the maximum operating altitude is 914 m (3000 ft).</i>
Storage	-15.2 to 10,670 m (-50 to 35,000 ft)

Standard Settings

The system setup program contains the standard settings for your computer.

 **NOTICE:** Unless you are an expert computer user, don't change the settings in the system setup program. Certain changes might make your computer work incorrectly.

See the following figure for an example of the `Main` program screen.

Main		Advanced	Security	Power	Boot	Exit
Date (mm:dd:yy)	mm:dd:yy					Item Help
Time (hh:mm:ss)	hh:mm:ss					
BIOS version	zzzz					
Processor Type	Pentium® 4					
Processor Speed	zzzz GHz					
System Bus Speed	zzzz MHz					
Cache RAM	zzzz KB					
Service Tag	zzzzzz					
Total Memory	zzzz MB					
Memory Bank0	zzzz MB					
Memory Bank1	[Not Installed]					

→ ← Move Menu ↑ ↓ Move Item Tab: Move Field Enter: Select +/- /PU/PD: Value
 Esc: Exit F10: Save F1: General Help F5: Previous Values F9: Setup Defaults

Viewing Settings

- 1 Turn on (or restart) your computer.
- 2 When the blue DELL™ logo appears, press <F2> immediately.

If you wait too long and the operating system logo appears, continue to wait until you see the Microsoft® Windows® desktop. Then shut down your computer and try again.

System Setup Program Screens

The system setup screens are organized into the following sections:

- The menu bar at the top provides access to the main program screens:
 - **Main** provides settings for the basic computer configuration.
 - **Advanced** provides detailed settings for some computer features.
 - **Security** provides indications and settings for user and setup passwords.
 - **Power** provides settings for system power management features.
 - **Boot** provides information about how the computer starts.
 - **Exit** provides selections for saving and loading the program settings.

- The left side lists configuration options and their settings for the hardware installed in your computer.
You can change settings enclosed in brackets, but not those that are grayed out. Options identified by an arrowhead (>) provide access to submenus.
- The top-right side displays help information for a highlighted option.
- The bottom-right side lists keys and their functions for the displayed screen.

Clearing Forgotten Passwords



 **CAUTION:** Before you begin any of the procedures in this section, follow the safety instructions on page 9.

If you forget your supervisor or setup password, you cannot operate your computer or change settings in the system setup program until you clear the forgotten password(s).

- 1 Shut down the computer through the **Start** menu (see page 30).
 - 2 Ensure that your computer and attached devices are turned off. If your computer and attached devices did not automatically turn off when you shut down your computer, turn them off now.
-  **NOTICE:** To disconnect a network cable, first unplug the cable from your computer and then unplug it from the network wall jack.
- 3 Disconnect any telephone or telecommunication lines from the computer.
 - 4 Disconnect your computer and all attached devices from their electrical outlets, and then press the power button to ground the system board.

 **CAUTION:** To guard against electrical shock, always unplug your computer from the electrical outlet before opening the cover.

- 5 Remove the computer cover (see page 71).
-  **NOTICE:** Before touching anything inside your computer, ground yourself by touching an unpainted metal surface, such as the metal at the back of the computer. While you work, periodically touch an unpainted metal surface to dissipate any static electricity that could harm internal components.
- 6 Locate the 2-pin password jumper (see page 74) on the system board, and then attach the jumper to both pins.
When you receive your computer, the jumper is attached to only one pin.
 - 7 Replace the computer cover (see page 90).
 - 8 Connect your computer and devices to electrical outlets, and turn them on.

- 9 If you are prompted to press <F1> to continue, press <F1>.
- 10 After the Microsoft Windows desktop appears on your computer, shut down the computer (see page 30).
-  **NOTICE:** To disconnect a network cable, first unplug the cable from your computer and then unplug it from the network wall jack.
- 11 Turn off any attached devices and disconnect them from their electrical outlets.
- 12 Disconnect the power cable from your computer, and then press the power button to ground the system board.
- 13 Remove the computer cover (see page 71).
- 14 Remove the password jumper.
Attach the jumper to only one pin so that you do not lose it.
- 15 Replace the computer cover (see page 90).
-  **NOTICE:** To connect a network cable, first plug the cable into the network wall jack and then plug it into the computer.
- 16 Connect your computer and devices to electrical outlets, and turn them on.
- 17 If you are prompted to press <F1> to continue, press <F1>.

Replacing the Battery

 **CAUTION:** Before you begin any of the procedures in this section, follow the safety instructions on page 9.

A coin-cell battery maintains computer configuration, date, and time information. The battery can last several years.

If you have to repeatedly reset time and date information after turning on the computer, replace the battery.

 **CAUTION:** A new battery can explode if it is incorrectly installed. Replace the 3-V CR2032 battery only with the same or equivalent type recommended by the manufacturer. Discard used batteries according to the manufacturer's instructions.

- 1 Record all the screens in the system setup program (see page 95) so that you can restore the correct settings when you perform step 7.
- 2 Open the computer cover (see page 71).
- 3 Locate the battery socket (see page 74).

- 4 Remove the battery by carefully prying it out of its socket with your fingers or with a blunt, nonconducting object such as a plastic screwdriver.

➔ **NOTICE:** To avoid damage to the system board while you pry the battery loose, be sure to insert the plastic screwdriver between the battery and the socket (not the system board).

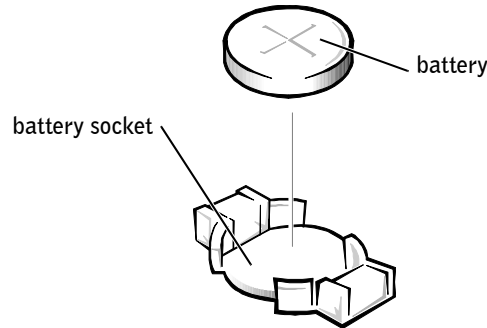

- 5 Insert the new battery into the socket with the side labeled "+" facing up and snap the battery into place.

➔ **NOTICE:** To connect a network cable, first plug the cable into the network wall jack and then plug it into the computer.

- 6 Connect your computer and devices to electrical outlets, and turn them on.
- 7 Access the system setup program (see page 95) and restore the settings you recorded in step 1.
- 8 Properly dispose of the old battery (see page 14).

Dell Technical Support Policy (U.S. Only)

Technician-assisted technical support requires the cooperation and participation of the customer in the troubleshooting process and provides for restoration of the operating system, application software, and hardware drivers to the original default configuration as shipped from Dell, as well as the verification of appropriate functionality of the computer and all Dell-installed hardware. In addition to this technician-assisted technical support, online technical support is available at support.dell.com. Additional technical support options may be available for purchase.

Dell provides limited technical support for the computer and any "Dell-installed" software and peripherals¹. Support for third-party software and peripherals is provided by the original manufacturer, including those purchased and/or installed through Dell Software and Peripherals, Readyware, and Custom Factory Integration².

- ¹ Repair services are provided pursuant to the terms and conditions of your limited warranty and any optional support service contract purchased with the computer.
- ² All Dell-standard components included in a Custom Factory Integration (CFI) project are covered by the standard Dell limited warranty for your computer. However, Dell also extends a parts replacement program to cover all nonstandard, third-party hardware components integrated through CFI for the duration of the computer's service contract.

Definition of "Dell-Installed" Software and Peripherals

Dell-installed software includes the operating system and some of the application software that is preinstalled on the computer during the manufacturing process (Microsoft Office, Norton Antivirus, and so on).

Dell-installed peripherals include any internal expansion cards, or Dell-branded module bay or PC Card accessories. In addition, any Dell-branded monitors, keyboards, mice, speakers, microphones for telephonic modems, docking stations/port replicators, networking products, and all associated cabling are included.

Definition of "Third-Party" Software and Peripherals

Third-party software and peripherals include any peripheral, accessory, or application software sold by Dell not under the Dell brand (printers, scanners, cameras, games, and so on). Support for all third-party software and peripherals is provided by the original manufacturer of the product.

Contacting Dell



NOTE: Toll-free numbers are for use within the country for which they are listed.

To contact Dell electronically, you can access the following websites:

- www.dell.com
- support.dell.com (technical support)
- premiersupport.dell.com (technical support for educational, government, healthcare, and medium/large business customers, including Premier, Platinum, and Gold customers)

For specific web addresses for your country, find the appropriate country section in the table below.

When you need to contact Dell, use the electronic addresses, telephone numbers, and codes provided in the following table. If you need assistance in determining which codes to use, contact a local or an international operator.

Country (City) International Access Code Country Code City Code	Department Name or Service Area, Website and E-Mail Address	Area Codes, Local Numbers, and Toll-Free Numbers
Anguilla	General Support	toll-free: 800-335-0031
Antigua and Barbuda	General Support	1-800-805-5924
Argentina (Buenos Aires)	Website: www.dell.com.ar	
International Access Code: 00	Tech Support and Customer Care	toll-free: 0-800-444-0733
Country Code: 54	Sales	0-810-444-3355
City Code: 11	Tech Support Fax	11 4515 7139
	Customer Care Fax	11 4515 7138
Aruba	General Support	toll-free: 800-1578
Australia (Sydney)	E-mail (Australia): au_tech_support@dell.com	
International Access Code: 0011	E-mail (New Zealand): nz_tech_support@dell.com	
Country Code: 61	Home and Small Business	1-300-65-55-33
City Code: 2	Government and Business	toll-free: 1-800-633-559
	Preferred Accounts Division (PAD)	toll-free: 1-800-060-889
	Customer Care	toll-free: 1-800-819-339
	Corporate Sales	toll-free: 1-800-808-385
	Transaction Sales	toll-free: 1-800-808-312
	Fax	toll-free: 1-800-818-341

Country (City) International Access Code Country Code City Code	Department Name or Service Area, Website and E-Mail Address	Area Codes, Local Numbers, and Toll-Free Numbers
Austria (Vienna)	Website: support.euro.dell.com	
International Access Code: 900	E-mail: tech_support_central_europe@dell.com	
Country Code: 43	Home/Small Business Sales	0820 240 530 00
City Code: 1	Home/Small Business Fax	0820 240 530 49
	Home/Small Business Customer Care	0820 240 530 14
	Preferred Accounts/Corporate Customer Care	0820 240 530 16
	Home/Small Business Technical Support	0820 240 530 14
	Preferred Accounts/Corporate Technical Support	0660 8779
	Switchboard	0820 240 530 00
Bahamas	General Support	toll-free: 1-866-278-6818
Barbados	General Support	1-800-534-3066
Belgium (Brussels)	Website: support.euro.dell.com	
International Access Code: 00	E-mail: tech_be@dell.com	
Country Code: 32	E-mail for French Speaking Customers: support.euro.dell.com/be/fr/emaildell/	
City Code: 2	Technical Support	02 481 92 88
	Customer Care	02 481 91 19
	Corporate Sales	02 481 91 00
	Fax	02 481 92 99
	Switchboard	02 481 91 00
Bermuda	General Support	1-800-342-0671
Bolivia	General Support	toll-free: 800-10-0238
Brazil	Website: www.dell.com/br	
International Access Code: 00	Customer Support, Technical Support	0800 90 3355
Country Code: 55	Tech Support Fax	51 481 5470
City Code: 51	Customer Care Fax	51 481 5480
	Sales	0800 90 3390
British Virgin Islands	General Support	toll-free: 1-866-278-6820

Country (City) International Access Code Country Code City Code	Department Name or Service Area, Website and E-Mail Address	Area Codes, Local Numbers, and Toll-Free Numbers
Brunei Country Code: 673	Customer Technical Support (Penang, Malaysia)	604 633 4966
	Customer Service (Penang, Malaysia)	604 633 4949
	Transaction Sales (Penang, Malaysia)	604 633 4955
Canada (North York, Ontario) International Access Code: 011	Online Order Status: www.dell.ca/ostatus	
	AutoTech (automated technical support)	toll-free: 1-800-247-9362
	TechFax	toll-free: 1-800-950-1329
	Customer Care (Home Sales/Small Business)	toll-free: 1-800-847-4096
	Customer Care (med./large business, government)	toll-free: 1-800-326-9463
	Technical Support (Home Sales/Small Business)	toll-free: 1-800-847-4096
	Technical Support (med./large bus., government)	toll-free: 1-800-387-5757
	Sales (Home Sales/Small Business)	toll-free: 1-800-387-5752
	Sales (med./large bus., government)	toll-free: 1-800-387-5755
Spare Parts Sales & Extended Service Sales	1 866 440 3355	
Cayman Islands	General Support	1-800-805-7541
Chile (Santiago) Country Code: 56 City Code: 2	Sales, Customer Support, and Technical Support	toll-free: 1230-020-4823

Country (City) International Access Code Country Code City Code	Department Name or Service Area, Website and E-Mail Address	Area Codes, Local Numbers, and Toll-Free Numbers
China (Xiamen) Country Code: 86 City Code: 592	Tech Support website: support.ap.dell.com/china	
	Tech Support E-mail: cn_support@dell.com	
	Tech Support Fax	818 1350
	Home and Small Business Technical Support	toll-free: 800 858 2437
	Corporate Accounts Technical Support	toll-free: 800 858 2333
	Customer Experience	toll-free: 800 858 2060
	Home and Small Business	toll-free: 800 858 2222
	Preferred Accounts Division	toll-free: 800 858 2062
	Large Corporate Accounts GCP	toll-free: 800 858 2055
	Large Corporate Accounts Key Accounts	toll-free: 800 858 2628
	Large Corporate Accounts North	toll-free: 800 858 2999
	Large Corporate Accounts North Government and Education	toll-free: 800 858 2955
	Large Corporate Accounts East	toll-free: 800 858 2020
	Large Corporate Accounts East Government and Education	toll-free: 800 858 2669
	Large Corporate Accounts Queue Team	toll-free: 800 858 2572
	Large Corporate Accounts South	toll-free: 800 858 2355
Large Corporate Accounts West	toll-free: 800 858 2811	
Large Corporate Accounts Spare Parts	toll-free: 800 858 2621	
Colombia	General Support	980-9-15-3978
Costa Rica	General Support	0800-012-0435
Czech Republic (Prague) International Access Code: 00 Country Code: 420 City Code: 2	Website: support.euro.dell.com	
	E-mail: czech_dell@dell.com	
	Technical Support	02 2186 27 27
	Customer Care	02 2186 27 11
	Fax	02 2186 27 14
	TechFax	02 2186 27 28
Switchboard	02 2186 27 11	

Country (City) International Access Code Country Code City Code	Department Name or Service Area, Website and E-Mail Address	Area Codes, Local Numbers, and Toll-Free Numbers
Denmark (Copenhagen) International Access Code: 00 Country Code: 45	Website: support.euro.dell.com E-mail Support (portable computers): den_nbk_support@dell.com E-mail Support (desktop computers): den_support@dell.com E-mail Support (servers): Nordic_server_support@dell.com	
	Technical Support	7023 0182
	Customer Care (Relational)	7023 0184
	Home/Small Business Customer Care	3287 5505
	Switchboard (Relational)	3287 1200
	Fax Switchboard (Relational)	3287 1201
	Switchboard (Home/Small Business)	3287 5000
	Fax Switchboard (Home/Small Business)	3287 5001
Dominica	General Support	toll-free: 1-866-278-6821
Dominican Republic	General Support	1-800-148-0530
Ecuador	General Support	toll-free: 999-119
El Salvador	General Support	01-899-753-0777
Finland (Helsinki) International Access Code: 990 Country Code: 358 City Code: 9	Website: support.euro.dell.com E-mail: fin_support@dell.com E-mail Support (servers): Nordic_support@dell.com	
	Technical Support	09 253 313 60
	Technical Support Fax	09 253 313 81
	Relational Customer Care	09 253 313 38
	Home/Small Business Customer Care	09 693 791 94
	Fax	09 253 313 99
	Switchboard	09 253 313 00

Country (City) International Access Code Country Code City Code	Department Name or Service Area, Website and E-Mail Address	Area Codes, Local Numbers, and Toll-Free Numbers
France (Paris) (Montpellier) International Access Code: 00 Country Code: 33 City Codes: (1) (4)	Website: support.euro.dell.com	
	E-mail: support.euro.dell.com/fr/fr/emaildell/	
	Home and Small Business	
	Technical Support	0825 387 270
	Customer Care	0825 823 833
	Switchboard	0825 004 700
	Switchboard (calls from outside of France)	04 99 75 40 00
	Sales	0825 004 700
	Fax	0825 004 701
	Fax (calls from outside of France)	04 99 75 40 01
	Corporate	
	Technical Support	0825 004 719
	Customer Care	0825 338 339
	Switchboard	01 55 94 71 00
	Sales	01 55 94 71 00
Fax	01 55 94 71 01	
Germany (Langen) International Access Code: 00 Country Code: 49 City Code: 6103	Website: support.euro.dell.com	
	E-mail: tech_support_central_europe@dell.com	
	Technical Support	06103 766-7200
	Home/Small Business Customer Care	0180-5-224400
	Global Segment Customer Care	06103 766-9570
	Preferred Accounts Customer Care	06103 766-9420
	Large Accounts Customer Care	06103 766-9560
	Public Accounts Customer Care	06103 766-9555
Switchboard	06103 766-7000	

Country (City) International Access Code Country Code City Code	Department Name or Service Area, Website and E-Mail Address	Area Codes, Local Numbers, and Toll-Free Numbers
Greece	Website: support.euro.dell.com	
International Access Code: 00	E-mail: support.euro.dell.com/gr/en/emaildell/	
Country Code: 30	Technical Support	080044149518
	Gold Technical Support	08844140083
	Switchboard	2108129800
	Sales	2108129800
	Fax	2108129812
Grenada	General Support	toll-free: 1-866-540-3355
Guatemala	General Support	1-800-999-0136
Guyana	General Support	toll-free: 1-877-270-4609
Hong Kong	Website: support.ap.dell.com	
International Access Code: 001	E-mail: ap_support@dell.com	
Country Code: 852	Technical Support (Dimension™ and Inspiron™)	296 93188
	Technical Support (OptiPlex™, Latitude™, and Dell Precision™)	296 93191
	Customer Service (non-technical, post-sales issues)	800 93 8291
	Transaction Sales	toll-free: 800 96 4109
	Large Corporate Accounts HK	toll-free: 800 96 4108
	Large Corporate Accounts GCP HK	toll-free: 800 90 3708
India	Technical Support	1600 33 8045
	Sales	1600 33 8044

Country (City) International Access Code Country Code City Code	Department Name or Service Area, Website and E-Mail Address	Area Codes, Local Numbers, and Toll-Free Numbers
Ireland (Cherrywood)	Website: support.euro.dell.com	
International Access Code: 16	E-mail: dell_direct_support@dell.com	
Country Code: 353	Ireland Technical Support	1850 543 543
City Code: 1	U.K. Technical Support (dial within U.K. only)	0870 908 0800
	Home User Customer Care	01 204 4014
	Small Business Customer Care	01 204 4014
	U.K. Customer Care (dial within U.K. only)	0870 906 0010
	Corporate Customer Care	1850 200 982
	Corporate Customer Care (dial within U.K. only)	0870 907 4499
	Ireland Sales	01 204 4444
	U.K. Sales (dial within U.K. only)	0870 907 4000
	Fax/SalesFax	01 204 0103
	Switchboard	01 204 4444
Italy (Milan)	Website: support.euro.dell.com	
International Access Code: 00	E-mail: support.euro.dell.com/it/it/emaildell/	
Country Code: 39	Home and Small Business	
City Code: 02	Technical Support	02 577 826 90
	Customer Care	02 696 821 14
	Fax	02 696 821 13
	Switchboard	02 696 821 12
	Corporate	
	Technical Support	02 577 826 90
	Customer Care	02 577 825 55
	Fax	02 575 035 30
	Switchboard	02 577 821
Jamaica	General Support (dial from within Jamaica only)	1-800-682-3639

Country (City) International Access Code Country Code City Code	Department Name or Service Area, Website and E-Mail Address	Area Codes, Local Numbers, and Toll-Free Numbers
Japan (Kawasaki)	Website: support.jp.dell.com	
International Access Code: 001	Technical Support (servers)	toll-free: 0120-198-498
Country Code: 81	Technical Support outside of Japan (servers)	81-44-556-4162
City Code: 44	Technical Support (Dimension™ and Inspiron™)	toll-free: 0120-198-226
	Technical Support outside of Japan (Dimension and Inspiron)	81-44-520-1435
	Technical Support (Dell Precision™, OptiPlex™, and Latitude™)	toll-free:0120-198-433
	Technical Support outside of Japan (Dell Precision, OptiPlex, and Latitude)	81-44-556-3894
	Faxbox Service	044-556-3490
	24-Hour Automated Order Service	044-556-3801
	Customer Care	044-556-4240
	Business Sales Division (up to 400 employees)	044-556-1465
	Preferred Accounts Division Sales (over 400 employees)	044-556-3433
	Large Corporate Accounts Sales (over 3500 employees)	044-556-3430
	Public Sales (government agencies, educational institutions, and medical institutions)	044-556-1469
	Global Segment Japan	044-556-3469
	Individual User	044-556-1760
	Switchboard	044-556-4300
Korea (Seoul)	Technical Support	toll-free: 080-200-3800
International Access Code: 001	Sales	toll-free: 080-200-3600
Country Code: 82	Customer Service (Seoul, Korea)	toll-free: 080-200-3800
City Code: 2	Customer Service (Penang, Malaysia)	604 633 4949
	Fax	2194-6202
	Switchboard	2194-6000

Country (City) International Access Code Country Code City Code	Department Name or Service Area, Website and E-Mail Address	Area Codes, Local Numbers, and Toll-Free Numbers
Latin America	Customer Technical Support (Austin, Texas, U.S.A.)	512 728-4093
	Customer Service (Austin, Texas, U.S.A.)	512 728-3619
	Fax (Technical Support and Customer Service) (Austin, Texas, U.S.A.)	512 728-3883
	Sales (Austin, Texas, U.S.A.)	512 728-4397
	SalesFax (Austin, Texas, U.S.A.)	512 728-4600 or 512 728-3772
Luxembourg	Website: support.euro.dell.com	
International Access Code: 00	E-mail: tech_be@dell.com	
Country Code: 352	Technical Support (Brussels, Belgium)	3420808075
	Home/Small Business Sales (Brussels, Belgium)	toll-free: 080016884
	Corporate Sales (Brussels, Belgium)	02 481 91 00
	Customer Care (Brussels, Belgium)	02 481 91 19
	Fax (Brussels, Belgium)	02 481 92 99
	Switchboard (Brussels, Belgium)	02 481 91 00
Macao	Technical Support	toll-free: 0800 582
Country Code: 853	Customer Service (Penang, Malaysia)	604 633 4949
	Transaction Sales	toll-free: 0800 581
Malaysia (Penang)	Technical Support	toll-free: 1 800 888 298
International Access Code: 00	Customer Service	04 633 4949
Country Code: 60	Transaction Sales	toll-free: 1 800 888 202
City Code: 4	Corporate Sales	toll-free: 1 800 888 213

Country (City) International Access Code Country Code City Code	Department Name or Service Area, Website and E-Mail Address	Area Codes, Local Numbers, and Toll-Free Numbers
Mexico International Access Code: 00 Country Code: 52	Customer Technical Support Sales Customer Service Main	001-877-384-8979 or 001-877-269-3383 50-81-8800 or 01-800-888-3355 001-877-384-8979 or 001-877-269-3383 50-81-8800 or 01-800-888-3355
Montserrat	General Support	toll-free: 1-866-278-6822
Netherlands Antilles	General Support	001-800-882-1519
Netherlands (Amsterdam) International Access Code: 00 Country Code: 31 City Code: 20	Website: support.euro.dell.com E-mail (Technical Support): (Enterprise): nl_server_support@dell.com (Latitude): nl_latitude_support@dell.com (Inspiron): nl_inspiron_support@dell.com (Dimension): nl_dimension_support@dell.com (OptiPlex): nl_optiplex_support@dell.com (Dell Precision): nl_workstation_support@dell.com	
	Technical Support	020 674 45 00
	Technical Support Fax	020 674 47 66
	Home/Small Business Customer Care	020 674 42 00
	Relational Customer Care	020 674 4325
	Home/Small Business Sales	020 674 55 00
	Relational Sales	020 674 50 00
	Home/Small Business Sales Fax	020 674 47 75
	Relational Sales Fax	020 674 47 50
	Switchboard	020 674 50 00
	Switchboard Fax	020 674 47 50

Country (City) International Access Code Country Code City Code	Department Name or Service Area, Website and E-Mail Address	Area Codes, Local Numbers, and Toll-Free Numbers
New Zealand	E-mail (New Zealand): nz_tech_support@dell.com	
International Access Code: 00	E-mail (Australia): au_tech_support@dell.com	
Country Code: 64	Home and Small Business	0800 446 255
	Government and Business	0800 444 617
	Sales	0800 441 567
	Fax	0800 441 566
Nicaragua	General Support	001-800-220-1006
Norway (Lysaker)	Website: support.euro.dell.com	
International Access Code: 00	E-mail Support (portable computers):	
Country Code: 47	nor_nbk_support@dell.com	
	E-mail Support (desktop computers):	
	nor_support@dell.com	
	E-mail Support (servers):	
	nordic_server_support@dell.com	
	Technical Support	671 16882
	Relational Customer Care	671 17514
	Home/Small Business Customer Care	23162298
	Switchboard	671 16800
	Fax Switchboard	671 16865
Panama	General Support	001-800-507-0962
Peru	General Support	0800-50-669
Poland (Warsaw)	Website: support.euro.dell.com	
International Access Code: 011	E-mail: pl_support@dell.com	
Country Code: 48	Customer Service Phone	57 95 700
City Code: 22	Customer Care	57 95 999
	Sales	57 95 999
	Customer Service Fax	57 95 806
	Reception Desk Fax	57 95 998
	Switchboard	57 95 999

Country (City) International Access Code Country Code City Code	Department Name or Service Area, Website and E-Mail Address	Area Codes, Local Numbers, and Toll-Free Numbers
Portugal	Website: support.euro.dell.com	
International Access Code: 00	E-mail: support.euro.dell.com/pt/en/emailldell/	
Country Code: 351	Technical Support	707200149
	Customer Care	800 300 413
	Sales	800 300 410 or 800 300 411 or 800 300 412 or 21 422 07 10
	Fax	21 424 01 12
Puerto Rico	General Support	1-800-805-7545
St. Kitts and Nevis	General Support	toll-free: 1-877-441-4731
St. Lucia	General Support	1-800-882-1521
St. Vincent and the Grenadines	General Support	toll-free: 1-877-270-4609
Singapore (Singapore)	Technical Support	toll-free: 800 6011 051
International Access Code: 005	Customer Service (Penang, Malaysia)	604 633 4949
Country Code: 65	Transaction Sales	toll-free: 800 6011 054
	Corporate Sales	toll-free: 800 6011 053
South Africa (Johannesburg)	Website: support.euro.dell.com	
International Access Code: 09/091	E-mail: dell_za_support@dell.com	
Country Code: 27	Technical Support	011 709 7710
City Code: 11	Customer Care	011 709 7707
	Sales	011 709 7700
	Fax	011 706 0495
	Switchboard	011 709 7700
Southeast Asian and Pacific Countries	Customer Technical Support, Customer Service, and Sales (Penang, Malaysia)	604 633 4810

Country (City) International Access Code Country Code City Code	Department Name or Service Area, Website and E-Mail Address	Area Codes, Local Numbers, and Toll-Free Numbers
Spain (Madrid) International Access Code: 00 Country Code: 34 City Code: 91	Website: support.euro.dell.com E-mail: support.euro.dell.com/es/es/emaildell/ Home and Small Business Technical Support Customer Care Sales Switchboard Fax Corporate Technical Support Customer Care Switchboard Fax	902 100 130 902 118 540 902 118 541 902 118 541 902 118 539 902 100 130 902 118 546 91 722 92 00 91 722 95 83
Sweden (Upplands Vasby) International Access Code: 00 Country Code: 46 City Code: 8	Website: support.euro.dell.com E-mail: swe_support@dell.com E-mail Support for Latitude and Inspiron: Swe-nbk_kats@dell.com E-mail Support for OptiPlex: Swe_kats@dell.com E-mail Support for Servers: Nordic_server_support@dell.com Technical Support Relational Customer Care Home/Small Business Customer Care Employee Purchase Program (EPP) Support Fax Technical Support Sales	08 590 05 199 08 590 05 642 08 587 70 527 20 140 14 44 08 590 05 594 08 590 05 185

Country (City) International Access Code Country Code City Code	Department Name or Service Area, Website and E-Mail Address	Area Codes, Local Numbers, and Toll-Free Numbers
Switzerland (Geneva) International Access Code: 00 Country Code: 41 City Code: 22	Website: support.euro.dell.com E-mail: swisstech@dell.com E-mail for French-speaking HSB and Corporate Customers: support.euro.dell.com/ch/fr/emaildell/ Technical Support (Home and Small Business) Technical Support (Corporate) Customer Care (Home and Small Business) Customer Care (Corporate) Fax Switchboard	0844 811 411 0844 822 844 0848 802 202 0848 821 721 022 799 01 90 022 799 01 01
Taiwan International Access Code: 002 Country Code: 886	Technical Support (portable and desktop computers) Technical Support (servers) Transaction Sales Corporate Sales	toll-free: 00801 86 1011 toll-free: 0080 60 1256 toll-free: 0080 651 228 or 0800 33 556 toll-free: 0080 651 227 or 0800 33 555
Thailand International Access Code: 001 Country Code: 66	Technical Support Customer Service (Penang, Malaysia) Sales	toll-free: 0880 060 07 604 633 4949 toll-free: 0880 060 09
Trinidad/Tobago	General Support	1-800-805-8035
Turks and Caicos Islands	General Support	toll-free: 1-866-540-3355

Country (City) International Access Code Country Code City Code	Department Name or Service Area, Website and E-Mail Address	Area Codes, Local Numbers, and Toll-Free Numbers
U.K. (Bracknell)	Website: support.euro.dell.com	
International Access Code: 00	Customer Care website: support.euro.dell.com/uk/en/ECare/Form/Home.asp	
Country Code: 44		
City Code: 1344	E-mail: dell_direct_support@dell.com	
	Technical Support (Corporate/Preferred Accounts/PAD [1000+ employees])	0870 908 0500
	Technical Support (direct/PAD and general)	0870 908 0800
	Global Accounts Customer Care	01344 373 186
	Home and Small Business Customer Care	0870 906 0010
	Corporate Customer Care	01344 373 185
	Preferred Accounts (500–5000 employees) Customer Care	0870 906 0010
	Central Government Customer Care	01344 373 193
	Local Government & Education Customer Care	01344 373 199
	Health Customer Care	01344 373 194
	Home and Small Business Sales	0870 907 4000
	Corporate/Public Sector Sales	01344 860 456
Uruguay	General Support	toll-free: 000-413-598-2521

Country (City) International Access Code Country Code City Code	Department Name or Service Area, Website and E-Mail Address	Area Codes, Local Numbers, and Toll-Free Numbers
U.S.A. (Austin, Texas)	Automated Order-Status Service	toll-free: 1-800-433-9014
International Access Code: 011 Country Code: 1	AutoTech (portable and desktop computers) Consumer (Home and Home Office) Technical Support Customer Service DellNet™ Service and Support Employee Purchase Program (EPP) Customers Financial Services website: www.dellfinancialservices.com Financial Services (lease/loans) Financial Services (Dell Preferred Accounts [DPA]) Business Customer Service and Technical Support Employee Purchase Program (EPP) Customers Projectors Technical Support Public (government, education, and healthcare) Customer Service and Technical Support Employee Purchase Program (EPP) Customers Dell Sales Dell Outlet Store (Dell refurbished computers) Software and Peripherals Sales Spare Parts Sales Extended Service and Warranty Sales Fax Dell Services for the Deaf, Hard-of-Hearing, or Speech-Impaired	toll-free: 1-800-247-9362 toll-free: 1-800-624-9896 toll-free: 1-800-624-9897 toll-free: 1-877-Dellnet (1-877-335-5638) toll-free: 1-800-695-8133 toll-free: 1-877-577-3355 toll-free: 1-800-283-2210 toll-free: 1-800-822-8965 toll-free: 1-800-695-8133 toll-free: 1-877-459-7298 toll-free: 1-800-456-3355 toll-free: 1-800-234-1490 toll-free: 1-800-289-3355 or toll-free: 1-800-879-3355 toll-free: 1-888-798-7561 toll-free: 1-800-671-3355 toll-free: 1-800-357-3355 toll-free: 1-800-247-4618 toll-free: 1-800-727-8320 toll-free: 1-877-DELLTTY (1-877-335-5889)
U.S. Virgin Islands	General Support	1-877-673-3355
Venezuela	General Support	8001-3605

Returning Items for Warranty Repair or Credit

Prepare all items being returned, whether for repair or credit, as follows:

- 1 Call Dell to obtain an authorization number, and write it clearly and prominently on the outside of the box.
- 2 Include a copy of the invoice and a letter describing the reason for the return.
- 3 Include any accessories that belong with the item(s) being returned (power cables, CDs, guides, and so on) if the return is for credit.
- 4 Pack the equipment to be returned in the original (or equivalent) packing materials.

You are responsible for paying shipping expenses. You are also responsible for insuring any product returned, and you assume the risk of loss during shipment to Dell. Collect-on-delivery packages are not accepted.

Returns that are missing any of the preceding requirements will be refused at our receiving dock and returned to you.

Regulatory Notices

Electromagnetic Interference (EMI) is any signal or emission, radiated in free space or conducted along power or signal leads, that endangers the functioning of a radio navigation or other safety service or seriously degrades, obstructs, or repeatedly interrupts a licensed radio communications service. Radio communications services include but are not limited to AM/FM commercial broadcast, television, cellular services, radar, air-traffic control, pager, and Personal Communication Services (PCS). These licensed services, along with unintentional radiators such as digital devices, including computer systems, contribute to the electromagnetic environment.

Electromagnetic Compatibility (EMC) is the ability of items of electronic equipment to function properly together in the electronic environment. While this computer system has been designed and determined to be compliant with regulatory agency limits for EMI, there is no guarantee that interference will not occur in a particular installation. If this equipment does cause interference with radio communications services, which can be determined by turning the equipment off and on, you are encouraged to try to correct the interference by one or more of the following measures:

- Reorient the receiving antenna.
- Relocate the computer with respect to the receiver.

- Move the computer away from the receiver.
- Plug the computer into a different outlet so that the computer and the receiver are on different branch circuits.

If necessary, consult a Dell Technical Support representative or an experienced radio/television technician for additional suggestions.

For additional regulatory information, see the *Tell Me How* help file that accompanied your computer. To access the help file, see page 34.

NOM Information (Mexico Only)

The following information is provided on the device(s) described in this document in compliance with the requirements of the official Mexican standards (NOM):

Exporter:	Dell Computer Corporation One Dell Way Round Rock, TX 78682 512-338-4400
Importer:	Dell Computer de México, S.A. de C.V. Paseo de la Reforma 2620 - 11° Piso Col. Lomas Altas 11950 México, D.F.
Ship to:	Dell Computer de México, S.A. de C.V. al Cuidado de Kuehne & Nagel de México S. de R.I. Avenida Soles No. 55 Col. Peñon de los Baños 15520 México, D.F.
Model number:	MTC2
Supply voltage:	115/230 VAC
Frequency:	60–50 Hz
Input current rating:	5.0/2.5 A

Limited Warranties and Return Policy

Dell-branded hardware products purchased in the U.S. or Canada come with either a 90-day (U.S. only), one-year, two-year, three-year, or four-year limited warranty. To determine which warranty you purchased, see the invoice that accompanied your hardware product(s). The following sections describe the limited warranties and return policy for the U.S., the limited warranties and return policy for Canada, and the manufacturer guarantee for Latin America and the Caribbean.

Limited Warranty for the U.S.

What is covered by this limited warranty?

This limited warranty covers defects in materials and workmanship in your—our end-user customer's—Dell-branded hardware products, including Dell-branded monitors, keyboards, wireless access points, and pointing devices (mice).

What is not covered by this limited warranty?

This limited warranty does not cover:

- Software, including the operating system and software added to the Dell-branded hardware products through our factory-integration system, third-party software, or the reloading of software
- Non-Dell-branded products and accessories
- Problems that result from:
 - External causes such as accident, abuse, misuse, or problems with electrical power
 - Servicing not authorized by us
 - Usage that is not in accordance with product instructions
 - Failure to follow the product instructions or failure to perform preventive maintenance
 - Problems caused by using accessories, parts, or components not supplied by us
- Products with missing or altered service tags or serial numbers
- Products for which we have not received payment

THIS WARRANTY GIVES YOU SPECIFIC LEGAL RIGHTS, AND YOU MAY ALSO HAVE OTHER RIGHTS WHICH VARY FROM STATE TO STATE (OR JURISDICTION TO JURISDICTION). DELL'S RESPONSIBILITY FOR MALFUNCTIONS AND DEFECTS IN HARDWARE IS LIMITED TO REPAIR AND REPLACEMENT AS SET FORTH IN THIS WARRANTY STATEMENT. ALL EXPRESS AND IMPLIED WARRANTIES FOR THE PRODUCT, INCLUDING BUT NOT LIMITED TO ANY IMPLIED WARRANTIES AND CONDITIONS OF MERCHANTABILITY AND FITNESS FOR A PARTICULAR PURPOSE, ARE LIMITED IN TIME TO THE TERM OF THE LIMITED WARRANTY PERIOD REFLECTED ON YOUR INVOICE. NO WARRANTIES, WHETHER EXPRESS OR IMPLIED, WILL APPLY AFTER THE LIMITED WARRANTY PERIOD HAS EXPIRED. SOME STATES DO NOT ALLOW LIMITATIONS ON HOW LONG AN IMPLIED WARRANTY LASTS, SO THIS LIMITATION MAY NOT APPLY TO YOU.

WE DO NOT ACCEPT LIABILITY BEYOND THE REMEDIES PROVIDED FOR IN THIS LIMITED WARRANTY OR FOR CONSEQUENTIAL OR INCIDENTAL DAMAGES, INCLUDING, WITHOUT LIMITATION, ANY LIABILITY FOR THIRD PARTY CLAIMS AGAINST YOU FOR DAMAGES, FOR PRODUCTS NOT BEING AVAILABLE FOR USE, OR FOR LOST DATA OR LOST SOFTWARE. OUR LIABILITY WILL BE NO MORE THAN THE AMOUNT YOU PAID FOR THE PRODUCT THAT IS THE SUBJECT OF A CLAIM. THIS IS THE MAXIMUM AMOUNT FOR WHICH WE ARE RESPONSIBLE.

SOME STATES DO NOT ALLOW THE EXCLUSION OR LIMITATION OF INCIDENTAL OR CONSEQUENTIAL DAMAGES, SO THE ABOVE LIMITATION OR EXCLUSION MAY NOT APPLY TO YOU.

How long does this limited warranty last?

This limited warranty lasts for the time period indicated on your invoice, except that the limited warranty on Dell-branded batteries lasts only one year and the limited warranty on the lamps for Dell-branded projectors lasts only ninety days. The limited warranty begins on the date of the invoice. The warranty period is not extended if we repair or replace a warranted product or any parts. Dell may change the availability of limited warranties, at its discretion, but any changes will not be retroactive.

What do I do if I need warranty service?

Before the warranty expires, please call us at the relevant number listed in the following table. Please also have your Dell service tag number or order number available.

Individual Home Consumers:	U.S. Only
Technical Support	1-800-624-9896
Customer Service	1-800-624-9897
Individual Home Consumers who purchased through an Employee Purchase Program:	
Technical Support and Customer Service	1-800-822-8965
Home and Small Business Commercial Customers:	
Technical Support and Customer Service	1-800-456-3355
Medium, Large, or Global Commercial Customers, Healthcare Customers, and Value Added Resellers (VARs):	
Technical Support and Customer Service	1-800-822-8965
Government and Education Customers:	
Technical Support and Customer Service	1-800-234-1490
Dell-Branded Memory	1-888-363-5150

What will Dell do?

During the first 90 days of the 90-day limited warranty and the first year of all other limited warranties: For the first 90 days of the 90-day limited warranty and the first year of all other limited warranties, we will repair any Dell-branded hardware products returned to us that prove to be defective in materials or workmanship. If we are not able to repair the product, we will replace it with a comparable product that is new or refurbished.

When you contact us, we will issue a Return Material Authorization Number for you to include with your return. You must return the products to us in their original or equivalent packaging, prepay shipping charges, and insure the shipment or accept the risk if the product is lost or damaged in shipment. We will return the repaired or replacement products to you. We will pay to ship the repaired or replaced products to you if you use an address in the United States (excluding Puerto Rico and U.S. possessions and territories). Otherwise, we will ship the product to you freight collect.

If we determine that the product is not covered under this warranty, we will notify you and inform you of service alternatives that are available to you on a fee basis.

NOTE: Before you ship the product(s) to us, make sure to back up the data on the hard drive(s) and any other storage device(s) in the product(s). Remove any confidential, proprietary, or personal information and removable media such as floppy disks, CDs, or PC Cards. We are not responsible for any of your confidential, proprietary, or personal information; lost or corrupted data; or damaged or lost removable media.

During the remaining years: For the remaining period of the limited warranty, we will replace any defective part with new or refurbished parts, if we agree that it needs to be replaced. When you contact us, we will require a valid credit card number at the time you request a replacement part, but we will not charge you for the replacement part as long as you return the original part to us within thirty days after we ship the replacement part to you. If we do not receive the original part within thirty days, we will charge to your credit card the then-current standard price for that part.

We will pay to ship the part to you if you use an address in the United States (excluding Puerto Rico and U.S. possessions and territories). Otherwise, we will ship the part freight collect. We will also include a prepaid shipping container with each replacement part for your use in returning the replaced part to us.

NOTE: Before you replace parts, make sure to back up the data on the hard drive(s) and any other storage device(s) in the product(s). We are not responsible for lost or corrupted data.

What if I purchased a service contract?

If your service contract is with Dell, service will be provided to you under the terms of the service agreement. Please refer to that contract for details on how to obtain service.

If you purchased through us a service contract with one of our third-party service providers, please refer to that contract for details on how to obtain service.

How will you fix my product?

We use new and refurbished parts made by various manufacturers in performing warranty repairs and in building replacement parts and systems. Refurbished parts and systems are parts or systems that have been returned to Dell, some of which were never used by a customer. All parts and systems are inspected and tested for quality. Replacement parts and systems are covered for the remaining period of the limited warranty for the product you bought.

What do I do if I am not satisfied?

We pride ourselves on our great customer service. If you are not satisfied with the service you receive under this limited warranty, please let us know. We have found that the best way to resolve issues regarding our limited warranty is to work together. If, after those discussions, you are still not satisfied, we believe arbitration is the most expeditious way to resolve your concerns. Therefore, **ANY CLAIM, DISPUTE, OR CONTROVERSY (WHETHER IN CONTRACT, TORT, OR OTHERWISE, WHETHER PREEXISTING, PRESENT, OR FUTURE, AND INCLUDING STATUTORY, COMMON LAW, INTENTIONAL TORT, AND EQUITABLE CLAIMS) AGAINST DELL** arising from or relating to this limited warranty, its interpretation, or the breach, termination, or validity thereof, the relationships which result from this limited warranty (including, to the full extent permitted by applicable law, relationships with third parties), Dell's advertising, or any related purchase **SHALL BE RESOLVED EXCLUSIVELY AND FINALLY BY BINDING ARBITRATION ADMINISTERED BY THE NATIONAL ARBITRATION FORUM (NAF)** under its Code of Procedure then in effect (available via the Internet at www.arb-forum.com/ or via telephone at 1-800-474-2371). The arbitration will be limited solely to the dispute or controversy between you and Dell. Any award of the arbitrator(s) shall be final and binding on each of the parties, and may be entered as a judgment in any court of competent jurisdiction. Information may be obtained and claims may be filed with the NAF at P.O. Box 50191, Minneapolis, MN 55405. This provision applies only to individual home consumers and consumers who purchased through an employee purchase program. It does not apply to small, medium, large, and global commercial customers or government, education, and healthcare customers.

May I transfer the limited warranty?

Limited warranties on systems may be transferred if the current owner transfers ownership of the system and records the transfer with us. The limited warranty on Dell-branded memory may not be transferred. You may record your transfer by going to Dell's website:

- If you are an Individual Home Consumer, go to www.dell.com/us/en/dhs/topics/sbtopic_015_ccare.htm
- If you are a Small, Medium, Large, or Global Commercial Customer, go to www.dell.com/us/en/biz/topics/sbtopic_ccare_nav_015_ccare.htm
- If you are a Government, Education, or Healthcare Customer, or an Individual Consumer who purchased through an employee purchase program, go to www.dell.com/us/en/pub/topics/sbtopic_015_ccare.htm

If you do not have Internet access, call your customer care representative or call 1-800-624-9897.

"Total Satisfaction" Return Policy (U.S. Only)

We value our relationship with you and want to make sure that you're satisfied with your purchases. That's why we offer a "Total Satisfaction" return policy for most products that you—the end-user customer—purchase directly from Dell. Under this policy, you may return to Dell products that you purchased directly from Dell for a credit or a refund of the purchase price paid, less shipping and handling and applicable restocking fees as follows:

- **New Hardware Products and Accessories** — All new hardware, accessories, parts, and unopened software still in its sealed package, excluding the products listed below, may be returned within thirty days from the invoice date. To return applications software or an operating system that has been installed by Dell, you must return the entire computer. A different return policy applies to nondefective products purchased through Dell's Software and Peripherals division by customers of our Small and Medium Business divisions. Those products may be returned within thirty days from the invoice date, but a fifteen percent (15%) restocking fee will be deducted from any refund or credit. The "Total Satisfaction" Return Policy and Software and Peripherals division return policy are not available for Dell | EMC storage products, EMC-branded products, or enterprise software.

- **Reconditioned or Refurbished Dell-Branded Hardware Products and Parts** — All reconditioned or refurbished Dell-branded server and storage products may be returned within thirty days from the invoice date. All other reconditioned or refurbished Dell-branded hardware products and parts may be returned within fourteen days of the invoice date.

To return products, e-mail or call Dell customer service to receive a Credit Return Authorization Number within the return policy period applicable to the product you want to return. You must obtain a Credit Return Authorization Number in order to return the product. See "Contacting Dell" on page 100 (or www.dell.com/us/en/gen/contact.htm) to find the appropriate contact information for obtaining customer assistance.

You must ship the products to Dell within five days of the date that Dell issues the Credit Return Authorization Number. You must also return the products to Dell in their original packaging, in as-new condition along with any media, documentation, and all other items that were included in the original shipment, prepay shipping charges, and insure the shipment or accept the risk of loss or damage during shipment.

Limited Warranty Terms for Canada

What is covered by this limited warranty?

This limited warranty covers defects in materials and workmanship in your—our end-user customer's—Dell-branded hardware products, including Dell-branded monitors, keyboards, wireless access points, and pointing devices (mice).

What is not covered by this limited warranty?

This limited warranty does not cover:

- Software, including the operating system and software added to the Dell-branded hardware products through our factory-integration system, or the reloading of the software
- Non-Dell branded products and accessories
- Problems that result from:
 - External causes such as accident, abuse, misuse, or problems with electrical power
 - Servicing not authorized by us
 - Usage that is not in accordance with product instructions
 - Failure to follow the product instructions or failure to perform preventive maintenance
 - Problems caused by using accessories, parts, or components not supplied by us
- Products with missing or altered service tags or serial numbers
- Products for which we have not received payment

THIS WARRANTY GIVES YOU SPECIFIC LEGAL RIGHTS, AND YOU MAY ALSO HAVE OTHER RIGHTS WHICH VARY FROM PROVINCE TO PROVINCE. DELL'S RESPONSIBILITY FOR MALFUNCTIONS AND DEFECTS IN PRODUCT IS LIMITED TO REPAIR AND REPLACEMENT AS SET FORTH IN THIS WARRANTY STATEMENT, FOR THE TERM OF THE WARRANTY PERIOD REFLECTED ON YOUR INVOICE. EXCEPT FOR THE EXPRESS WARRANTIES CONTAINED IN THIS WARRANTY STATEMENT, DELL DISCLAIMS ALL OTHER WARRANTIES AND CONDITIONS, EXPRESS OR IMPLIED, INCLUDING WITHOUT LIMITATION IMPLIED WARRANTIES AND CONDITIONS OF MERCHANTABILITY AND FITNESS FOR A PARTICULAR PURPOSE, STATUTORY OR OTHERWISE. SOME PROVINCES DO NOT ALLOW THE EXCLUSION OF CERTAIN IMPLIED WARRANTIES OR CONDITIONS, OR LIMITATIONS ON HOW LONG AN IMPLIED WARRANTY OR CONDITION LASTS. THEREFORE, THE FOREGOING EXCLUSIONS AND LIMITATIONS MAY NOT APPLY TO YOU.

WE DO NOT ACCEPT LIABILITY BEYOND THE REMEDIES PROVIDED FOR IN THIS WARRANTY STATEMENT OR FOR SPECIAL, INDIRECT, CONSEQUENTIAL, OR INCIDENTAL DAMAGES, INCLUDING, WITHOUT LIMITATION, ANY LIABILITY FOR THIRD PARTY CLAIMS AGAINST YOU FOR DAMAGES, FOR PRODUCTS NOT BEING AVAILABLE FOR USE, OR FOR LOST DATA OR LOST SOFTWARE. OUR LIABILITY WILL BE NO MORE THAN THE AMOUNT YOU PAID FOR THE PRODUCT THAT IS THE SUBJECT OF A CLAIM. THIS IS THE MAXIMUM AMOUNT FOR WHICH WE ARE RESPONSIBLE.

SOME PROVINCES DO NOT ALLOW THE EXCLUSION OR LIMITATION OF SPECIAL, INDIRECT, INCIDENTAL, OR CONSEQUENTIAL DAMAGES, SO THE ABOVE LIMITATION OR EXCLUSION MAY NOT APPLY TO YOU.

How long does this limited warranty last?

This limited warranty lasts for the time period indicated on your invoice, except that the limited warranty on Dell-branded batteries lasts only one year and the limited warranty on the lamps for Dell-branded projectors lasts only ninety days. The limited warranty begins on the date of the invoice. The warranty period is not extended if we repair or replace a warranted product or any parts. Dell may change the terms and availability of limited warranties, at its discretion, but any changes will not be retroactive (that is, the warranty terms in place at the time of purchase will apply to your purchase).

What do I do if I need warranty service?

Before the warranty expires, please call us at the relevant number listed in the following table. Please also have your Dell service tag number or order number available.

Individual Home Consumers; Home Office and Small Business Customers:	Canada Only
Technical Support and Customer Service	1-800-847-4096
Medium, Large, and Global Commercial Customers; Government, Education, and Healthcare Customers; and Value Added Resellers (VARs):	
Technical Support	1-800-387-5757
Customer Service	1-800-326-9463
Government or Education Customers, or Individual Home Consumers who purchased through an Employee Purchase Program:	
Technical Support	1-800-387-5757
Customer Service	1-800-326-9463 (Extension 8221 for Individual Consumers)
Dell-Branded Memory	1-888-363-5150

What will Dell do?

During the first year of all limited warranties: During the first year of all limited warranties, we will repair any Dell-branded hardware products returned to us that prove to be defective in materials or workmanship. If we are not able to repair the product, we will replace it with a comparable product that is new or refurbished.

When you contact us, we will issue a Return Material Authorization Number for you to include with your return. You must return the products to us in their original or equivalent packaging, prepay shipping charges, and insure the shipment or accept the risk if the product is lost or damaged in shipment. We will return the repaired or replacement products to you. We will pay to ship the repaired or replaced products to you if you use an address in Canada. Otherwise, we will ship the product to you freight collect.

If we determine that the problem is not covered under this warranty, we will notify you and inform you of service alternatives that are available to you on a fee basis.

NOTE: Before you ship the product(s) to us, make sure to back up the data on the hard drive(s) and any other storage device(s) in the product(s). Remove any confidential, proprietary or personal information, removable media, such as floppy disks, CDs, or PC Cards. We are not responsible for any of your confidential, proprietary or personal information; lost or corrupted data; or damaged or lost removable media.

During the remaining years following the first year of all limited warranties: We will replace any defective part with new or refurbished parts, if we agree that it needs to be replaced. When you contact us, we will require a valid credit card number at the time you request a replacement part, but we will not charge you for the replacement part as long as you return the original part to us within thirty days after we ship the replacement part to you. If we do not receive the original part within thirty days, we will charge to your credit card the then-current standard price for that part.

We will pay to ship the part to you if you use an address in Canada. Otherwise, we will ship the part freight collect. We will also include a prepaid shipping container with each replacement part for your use in returning the replaced part to us.

NOTE: Before you replace parts, make sure to back up the data on the hard drive(s) and any other storage device(s) in the product(s). We are not responsible for lost or corrupted data.

What if I purchased an on-site service contract?

If your service contract is with Dell, service will be provided to you under the terms of the service contract. Please refer to that contract for details on how to obtain service. Dell's service contracts can be found online at www.dell.ca or by calling Customer Care at 1-800-847-4096. If you purchased through us a service contract with one of our third-party service providers, please refer to that contract (mailed to you with your invoice) for details on how to obtain service.

How will you fix my product?

We use new and refurbished parts made by various manufacturers in performing warranty repairs and in building replacement parts and systems. Refurbished parts and systems are parts or systems that have been returned to Dell, some of which were never used by a customer. All parts and systems are inspected and tested for quality. Replacement parts and systems are covered for the remaining period of the limited warranty for the product you bought. Dell owns all parts removed from repaired products.

What do I do if I am not satisfied?

We pride ourselves on our great customer service. If you are not satisfied with the service you receive under this limited warranty, please let us know. We have found that the best way to resolve issues regarding our limited warranty is to work together. If, after those discussions, you are still not satisfied, we believe arbitration is the most expeditious way to resolve your concerns. Therefore, **ANY CLAIM, DISPUTE, OR CONTROVERSY (WHETHER IN CONTRACT, TORT, OR OTHERWISE, WHETHER PREEXISTING, PRESENT OR FUTURE, AND INCLUDING STATUTORY, COMMON LAW, INTENTIONAL TORT, AND EQUITABLE CLAIMS) AGAINST DELL** arising from or relating to this limited warranty, its interpretation, or the breach, termination or validity thereof, the relationships which result from this limited warranty (including, to the full extent permitted by applicable law, relationships with third parties), Dell's advertising, or any related purchase **SHALL BE RESOLVED EXCLUSIVELY AND FINALLY BY BINDING ARBITRATION ADMINISTERED BY THE NATIONAL ARBITRATION FORUM (NAF)** under its Code of Procedure then in effect (available via the Internet at www.arb-forum.com/, or via telephone at 1-800-474-2371). The arbitration will be limited solely to the dispute or controversy between you and Dell. Any award of the arbitrator(s) shall be final and binding on each of the parties, and may be entered as a judgment in any court of competent jurisdiction. Information may be obtained and claims may be filed with the NAF at P.O. Box 50191, Minneapolis, MN 55405.

May I transfer the limited warranty?

Limited warranties on systems may be transferred if the current owner transfers ownership of the system and records the transfer with us. The limited warranty on Dell-branded memory may not be transferred. You may record your transfer by going to our website:

- If you are an Individual Home Consumer, go to www.dell.com/us/en/dhs/topics/sbtopic_016_ccare.htm
- If you are a Home Office, Small, Medium, Large, or Global Commercial Customer, go to www.dell.com/us/en/biz/topics/sbtopic_ccare_nav_016_ccare.htm
- If you are a Government, Education, or Healthcare Customer, or an Individual Home Consumer who purchased through an Employee Purchase Program, go to www.dell.com/us/en/pub/topics/sbtopic_016_ccare.htm

If you do not have Internet access, please call Dell at 1-800-326-9463.

"Total Satisfaction" Return Policy

If you are an end-user customer who bought new products directly from Dell, you may return them to Dell up to 30 days after you receive them for a refund or credit of the product purchase price. If you are an end-user customer who bought reconditioned or refurbished products from Dell, you may return them to Dell within 14 days after the date of invoice for a refund or credit of the product purchase price. In either case, the refund or credit will not include any shipping and handling charges shown on your invoice and will be subject to a fifteen percent (15%) restocking fee, unless otherwise prohibited by law. If you are an organization that bought the products under a written agreement with Dell, the agreement may contain different terms for the return of products than specified by this policy.

To return products, you must call Dell Customer Service at 1-800-387-5759 to receive a Credit Return Authorization Number. To expedite the process of your refund or credit, Dell expects you to return the products to Dell in their original packaging within five days of the date that Dell issues the Credit Return Authorization Number. You must also prepay shipping charges and insure the shipment or accept the risk of loss or damage during shipment. You may return software for a refund or credit only if the sealed package containing the floppy disk(s) or CD(s) is unopened. Returned products must be in as-new condition, and all of the manuals, floppy disk(s), CD(s), power cables, and other items included with a product must be returned with it. For customers who want to return, for refund or credit only, either application or operating system software that has been installed by Dell, the whole system must be returned, along with any media and documentation that may have been included in the original shipment.

The "Total Satisfaction" Return Policy does not apply to Dell | EMC storage products. It also does not apply to products purchased through Dell's Software and Peripherals division. For those products, please instead refer to Dell's Software and Peripheral's then-current return policy (see the following section, "Dell Software and Peripherals").

Dell Software and Peripherals

Third-Party Software and Peripherals Products

Similar to other resellers of software and peripherals, Dell does not warrant third-party products. Third-party software and peripheral products are covered by the warranties provided by the original manufacturer or publisher only. Third party manufacturer warranties vary from product to product. Consult your product documentation for specific warranty information. More information may also be available from the manufacturer or publisher.

While Dell offers a wide selection of software and peripheral products, we do not specifically test or guarantee that all of the products we offer work with any or all of the various models of Dell computers, nor do we test or guarantee all of the products we sell on the hundreds of different brands of computers available today. If you have questions about compatibility, we recommend and encourage you to contact the third-party software and peripheral product manufacturer or publisher directly.

Dell-Branded Peripheral Products

Dell does provide a limited warranty for new Dell-branded peripheral products (products for which Dell is listed as the manufacturer) such as monitors, batteries, memory, docking stations, and projectors). To determine which limited warranty applies to the product you purchased, see the Dell invoice and/or the product documentation that accompanied your product. Descriptions of Dell's limited warranties are described in preceding sections.

Return Policy

If you are an end-user customer who bought Dell Software and Peripherals products directly from a Dell company, you may return Dell Software and Peripherals products that are in as-new condition to Dell up to 30 days from the date of invoice for a refund of the product purchase price if already paid. This refund will not include any shipping and handling charges shown on your invoice; you are responsible for those.

To return products, you must call Dell Customer Service at 1-800-387-5759 to receive a Credit Return Authorization Number. You must ship the Dell Software and Peripherals products back to Dell in their original manufacturer's packaging (which must be in as-new condition), prepay shipping charges, and insure the shipment or accept the risk of loss or damage during shipment.

To qualify for refund or replacement, returned products must be in as-new condition, software products must be unopened, and all of the manuals, floppy disk(s), CD(s), power cables, and other items included with a product must be returned with it.

One-Year End-User Manufacturer Guarantee (Latin America and the Caribbean Only)

Guarantee

Dell Computer Corporation ("Dell") warrants to the end user in accordance with the following provisions that its branded hardware products, purchased by the end user from a Dell company or an authorized Dell distributor in Latin America or the Caribbean, will be free from defects in materials, workmanship, and design affecting normal use, for a period of one year from the original purchase date. Products for which proper claims are made will, at Dell's option, be repaired or replaced at Dell's expense. Dell owns all parts removed from repaired products. Dell uses new and reconditioned parts made by various manufacturers in performing repairs and building replacement products.

Exclusions

This Guarantee does not apply to defects resulting from: improper or inadequate installation, use, or maintenance; actions or modifications by unauthorized third parties or the end user; accidental or willful damage; or normal wear and tear.

Making a Claim

Claims must be made in Latin America or the Caribbean by contacting the Dell point of sale within the guarantee period. The end user must always supply proof of purchase, indicating name and address of the seller, date of purchase, model and serial number, name and address of the customer, and details of symptoms and configuration at the time of malfunction, including peripherals and software used. Otherwise, Dell may refuse the guarantee claim. Upon diagnosis of a warranted defect, Dell will make arrangements and pay for ground freight and insurance to and from Dell's repair/replacement center. The end user must ensure that the defective product is available for collection properly packed in original or equally protective packaging together with the details listed above and the return number provided to the end user by Dell.

Limitation and Statutory Rights

Dell makes no other warranty, guarantee or like statement other than as explicitly stated above, and this Guarantee is given in place of all other guarantees whatsoever, to the fullest extent permitted by law. In the absence of applicable legislation, this Guarantee will be the end user's sole and exclusive remedy against Dell or any of its affiliates, and neither Dell nor any of its affiliates shall be liable for loss of profit or contracts, or any other indirect or consequential loss arising from negligence, breach of contract, or howsoever.

This Guarantee does not impair or affect mandatory statutory rights of the end user against and/or any rights resulting from other contracts concluded by the end user with Dell and/or any other seller.

Dell World Trade LP

One Dell Way, Round Rock, TX 78682, USA

Dell Computadores do Brasil Ltda (CNPJ No. 72.381.189/0001-10)/

Dell Commercial do Brasil Ltda (CNPJ No. 03 405 822/0001-40)

Avenida Industrial Belgraf, 400

92990-000 - Eldorado do Sul – RS - Brasil

Dell Computer de Chile Ltda

Coyancura 2283, Piso 3- Of. 302,

Providencia, Santiago - Chile

Dell Computer de Colombia Corporation
Carrera 7 #115-33 Oficina 603
Bogota, Colombia

Dell Computer de Mexico SA de CV
Paseo de la Reforma 2620 - 11° Piso
Col. Lomas Altas
11950 México, D.F.

Intel® Warranty Statement for Pentium® and Celeron® Processors Only (U.S. and Canada Only)

Intel's Three Year Limited Warranty

Limited Warranty

Intel warrants that its family of Pentium® and Celeron® processors, if properly used and installed, will be free from defects in materials and workmanship and will substantially conform to Intel's publicly available specifications for a period of three (3) years after the date the Pentium or Celeron processor was purchased (whether purchased separately or as part of a computer system).

If the Pentium or Celeron processor, which is the subject of this Limited Warranty, fails during the warranty period for reasons covered by this Limited Warranty, Intel, at its option, will:

- REPAIR the Pentium or Celeron processor by means of hardware and/or software; OR
- REPLACE the Pentium or Celeron processor with another Pentium or Celeron processor; OR
- if Intel is unable to repair or replace the particular Pentium or Celeron processor,
- REFUND the then-current value of the Pentium or Celeron processor.

THIS LIMITED WARRANTY, AND ANY IMPLIED WARRANTIES THAT MAY EXIST UNDER STATE LAW, APPLY ONLY TO THE ORIGINAL PURCHASER OF THE PENTIUM OR CELERON PROCESSOR, OR PENTIUM OR CELERON PROCESSOR-BASED COMPUTER AND LAST ONLY FOR AS LONG AS SUCH PURCHASER CONTINUES TO OWN THE PROCESSOR.

Extent of Limited Warranty

Intel does not warrant that your Pentium or Celeron processor will be free from design defects or errors known as "errata." Current characterized errata are available upon request. This limited warranty is for purchasers in the United States and Canada only. The limited warranty does not cover any costs relating to removal or replacement of any Pentium or Celeron processors that are soldered or otherwise permanently affixed to your system's motherboard.

This limited warranty does not cover damages due to external causes, including accident, problems with electrical power, usage not in accordance with product instructions, misuse, neglect, alteration, repair, improper installation, or improper testing.

How to Obtain Warranty Service

To obtain warranty service for your Pentium or Celeron processor, you may contact your computer system manufacturer in accordance with its instructions, or you may contact Intel.

To request warranty service from Intel, you should call Intel at 1-800-628-8686 during the warranty period during normal business hours (Pacific Time), excluding holidays. Please be prepared to provide:

- (1) your name, address, and telephone numbers;
- (2) proof of purchase;
- (3) this Intel warranty card;
- (4) a description of the computer system including the brand and model; and
- (5) an explanation of the problem.

[Note: The Customer Service Representative may need additional information from you depending on the nature of the problem.]

The replacement processor is warranted under this written warranty and is subject to the same limitations and exclusions for the remainder of the original warranty period or one (1) year, whichever is longer.

WARRANTY LIMITATIONS AND EXCLUSIONS

THESE WARRANTIES REPLACE ALL OTHER WARRANTIES, EXPRESS OR IMPLIED INCLUDING, BUT NOT LIMITED TO, THE IMPLIED WARRANTIES OF MERCHANTABILITY AND FITNESS FOR A PARTICULAR PURPOSE. INTEL MAKES NO EXPRESS WARRANTIES BEYOND THOSE STATED HERE. INTEL DISCLAIMS ALL OTHER WARRANTIES, EXPRESS OR IMPLIED, INCLUDING, WITHOUT LIMITATION, IMPLIED WARRANTIES OF MERCHANTABILITY AND FITNESS FOR A PARTICULAR PURPOSE.

SOME LAWS DO NOT ALLOW THE EXCLUSION OF IMPLIED WARRANTIES SO THIS LIMITATION MAY NOT APPLY TO YOU. IF THESE LAWS APPLY, THEN ALL EXPRESS AND IMPLIED WARRANTIES ARE LIMITED IN DURATION TO THE LIMITED WARRANTY PERIOD. NO WARRANTIES APPLY AFTER THAT PERIOD. SOME LAWS DO NOT ALLOW LIMITATIONS ON HOW LONG AN IMPLIED WARRANTY LASTS, SO THIS LIMITATION MAY NOT APPLY TO YOU.

LIMITATIONS OF LIABILITY

INTEL'S RESPONSIBILITY UNDER THIS, OR ANY OTHER WARRANTY, IMPLIED OR EXPRESS, IS LIMITED TO REPAIR, REPLACEMENT OR REFUND, AS SET FORTH ABOVE. THESE REMEDIES ARE THE SOLE AND EXCLUSIVE REMEDIES FOR ANY BREACH OF WARRANTY. INTEL IS NOT RESPONSIBLE FOR INDIRECT, SPECIAL, INCIDENTAL, OR CONSEQUENTIAL DAMAGES RESULTING FROM ANY BREACH OF WARRANTY OR UNDER ANY OTHER LEGAL THEORY INCLUDING, BUT NOT LIMITED TO, LOST PROFITS, DOWNTIME, GOODWILL, DAMAGE TO OR REPLACEMENT OF EQUIPMENT AND PROPERTY, AND ANY COSTS OF RECOVERING, REPROGRAMMING, OR REPRODUCING ANY PROGRAM OR DATA STORED IN OR USED WITH A SYSTEM CONTAINING YOUR PENTIUM PROCESSOR. SOME JURISDICTIONS DO NOT ALLOW THE EXCLUSION OR LIMITATION OF INCIDENTAL OR CONSEQUENTIAL DAMAGES, SO THE ABOVE LIMITATIONS OR EXCLUSIONS MAY NOT APPLY TO YOU.

THE LIMITED WARRANTY GIVES YOU SPECIFIC LEGAL RIGHTS, AND YOU MAY ALSO HAVE OTHER RIGHTS THAT VARY FROM JURISDICTION TO JURISDICTION.

**Intel Pentium® and Celeron® Processors are backed by a three-year limited warranty.
Please refer to the reverse side of this card for complete warranty details.**

Intel's Commitment to Quality

Intel is committed to producing the highest quality processors available. That's why we have hundreds of people dedicated to continuously improve our design, manufacturing, and testing technology.

We put every one of our Pentium® and Celeron® processors through a rigorous battery of tests during the design and manufacturing processes.

To verify that the new chip will correctly run the software written for Intel Architecture processors, a team of Intel engineers is dedicated to compatibility testing. In a state-of-art lab, this group runs an extensive set of operating systems, applications, network tests and stress tests repeatedly to ensure that the processor is compatible with representative software.

Just as importantly, we work with hardware and software companies in the computer industry to ensure that our processors are compatible with their products.

Additionally, a sampling of Intel processors are subjected to a rigorous "burn-in" test whereby the chip is operated at higher-than-normal temperatures and voltages. During this burn-in period, the processor experiences the equivalent of weeks of normal usage. These units are monitored for failures as part of our ongoing quality assurance process.

As a result, today's microprocessors from Intel are among the most reliable components in computers.

What are 'Errata'?

Exhaustive product testing can highlight differences between the actual behavior of the microprocessor and its specifications. Sometimes the discrepancies are caused by a design defect or error, which we call errata. Rigorous validation identifies most errata during the development of the processor, but we do detect additional errata during the life cycle of a microprocessor.

When an erratum is identified, our engineers work to characterize it and find a solution. We work with system designers and software developers to ensure that the discrepancy does not affect their products. If necessary, special software or hardware solutions (sometimes known as "work arounds") are implemented in the system design to prevent computer users from encountering the problem. Errata may then be corrected in future revisions of the microprocessor.

No microprocessor is perfect, and Intel recognizes that some consumers want to know about any errata, whether or not the errata affect them. Intel makes documentation of all characterized Pentium and Celeron processor errata publicly available through our Technical Documentation Service.

At Intel, our goal is to make every computer user satisfied with his or her Pentium or Celeron processor. Should you have any questions, comments or concerns about your Intel microprocessor, please call us at 1-800-628-8686.

©1997, 1998 Intel Corporation. All rights reserved.

Index

A

audio. *See* sound

B

battery
disposal, 14
fixing problems, 34
replacing, 98

BIOS, 95

C

CD drive
adding, 78
fixing problems, 36

CD-RW drive
copying CDs, 26
fixing problems, 36

CDs
copying, 26
Easy CD Creator Basic, 26-27

Check Disk, 37

computer
back view, 70
error messages, 40
front view, 68
stops responding, 40
turning off, 30

computer cover
removing, 71
replacing, 90

conflicts
drivers, 59
resolving software and
hardware
incompatibilities, 63

contact numbers, 100

copying CDs
general information, 26
helpful tips, 28
how to copy a CD, 29

D

Dell Diagnostics, 56
Dell support policy, 99
Dell Support website, 16
Device Driver Rollback, 60
diagnostic lights, 54
diagnostics, Dell, 15, 56

display. *See* monitor

documentation
device, 15
finding, 15
finding information, 15
help file, 17
online, 16
Owner's Manual, 15
ResourceCD, 15
setup diagram, 16

drivers
definition, 59
reinstalling, 59
ResourceCD, 60
troubleshooting, 59

drives
fixing problems, 35

DVD drive
fixing problems, 36-37

E

electrostatic discharge, 13
e-mail
fixing problems, 37
error messages
diagnostic lights, 54
Express Service Code, 15

F

Files and Settings Transfer Wizard, 22

finding information, 15

finding solutions, 32

fixing problems

battery, 34

Dell Diagnostics, 56

drive, 35

e-mail, 37

error messages, 39

general, 40

Internet connection, 37

keyboard, 43

modem, 37

mouse, 44

network, 45

power, 45

printer, 46

scanner, 47

sound and speakers, 48

start-up error messages, 39

video and monitor, 50

floppy drive

fixing problems, 35

H

hard drive

fixing problems, 37

hardware

drivers, 59

fixing problems, 42

incompatibility, 63

Hardware Troubleshooter, 63

headphones

no sound, 49

Help and Support Center, 17

help file

accessing, 17, 34

home network, 23

I

Internet

connecting, 25

fixing problems, 37

setting up connection, 25

IRQ conflicts, 63

K

keyboard

fixing problems, 43

L

lights

back of computer, 54

diagnostic, 54

M

memory

adding, 83

Microsoft License Label, 15

modem

fixing problems, 37

monitor

fixing problems, 50

mouse

fixing problems, 44

N

network

fixing problems, 45

setting up, 23

Network Setup Wizard, 23

O

office network, 23

Operating System CD, 16

operating system

reinstallation

Windows XP, 64

P

password

clearing system setup, 97

power

fixing problems, 45

turning off, 30

printer

connecting, 20

fixing problems, 46

setting up, 20

troubleshooting, 46

program

crashes, 41

stops responding, 40

R

regulatory notices, 118
reinstalling
 drivers, 59
 Windows XP, 64
ResourceCD, 59-60
 Dell Diagnostics, 56
returning items, 118

S

safety instructions, 9
scanner
 fixing problems, 47
screen. *See* monitor
service tag number, 15
settings
 system setup program, 95
setup diagram, 16
shutdown, 30
software
 fixing problems, 40
 incompatibility, 63
 reinstalling software, 59
sound
 adjusting volume, 48
 fixing problems, 48
speaker
 adjusting volume, 48
 fixing problems, 48
System Restore, 61
system setup program, 95

T

technical assistance
 telephone numbers and
 addresses, 100
 warranty repair or credit, 118
Tell Me How help file
 accessing, 17, 34
transferring information to a
 new computer, 22
troubleshooting, 32
 advanced, 53
 conflicts, 63
 Dell Diagnostics, 56
 Device Driver Rollback, 60
 diagnostic lights, 54
 drivers, 59
 Hardware Troubleshooter, 63
 Help and Support Center, 17
 reinstalling Windows XP, 64
 System Restore, 61
turning off the computer, 30

V

video
 fixing problems, 50
volume
 adjusting, 48

W

warranty, 121
Windows License Label, 15

Windows XP

 Device Driver Rollback, 60
 Hardware Troubleshooter, 63
 Help and Support Center, 17,
 34
 reinstalling, 64
 scanner, 48
 shutdown, 30
 System Restore, 61

